

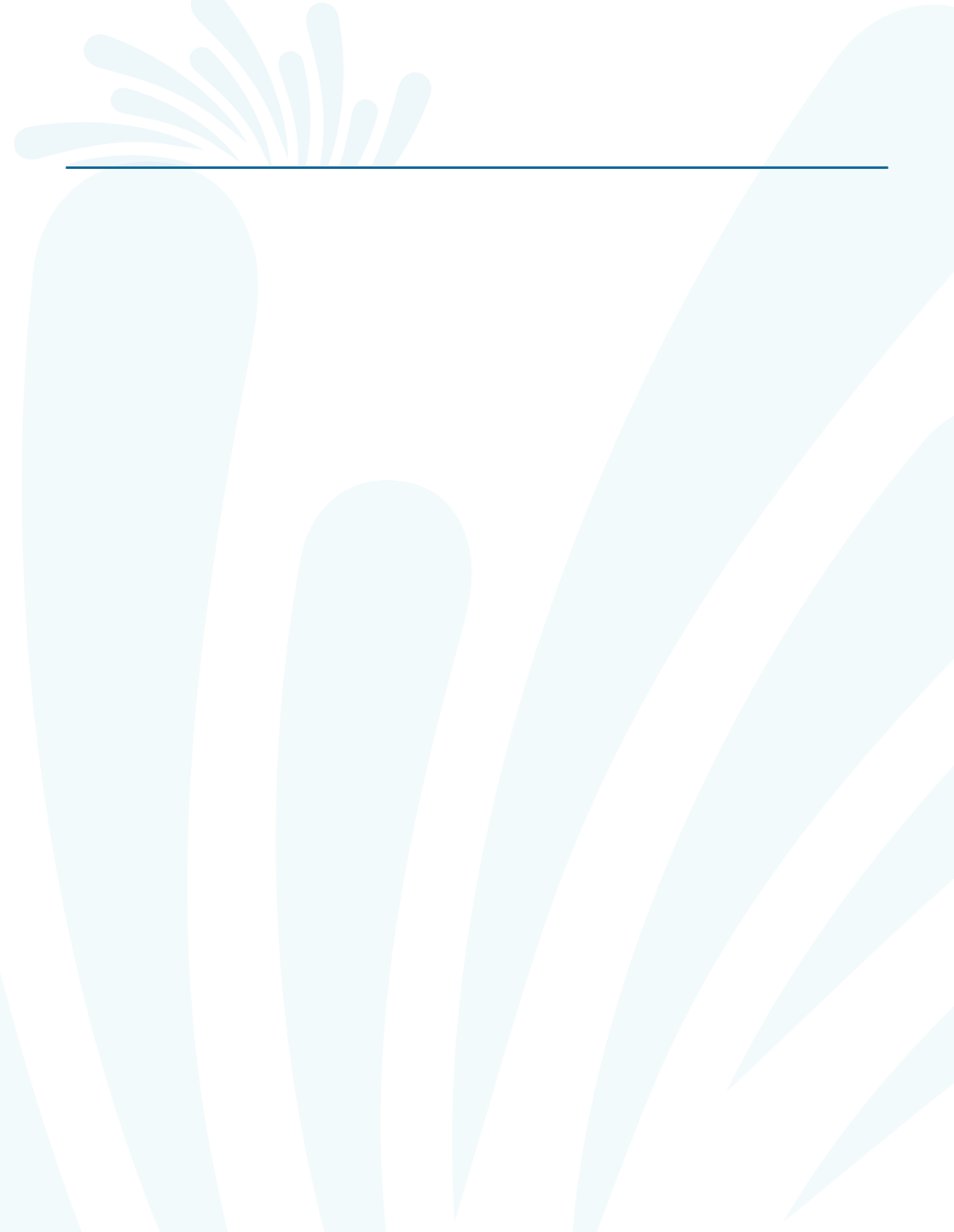

SUN  
& SOUL

# Owner's Manual





## Congratulations on becoming a new spa owner!

You can now enjoy the full benefits of relaxation, fun and family time that a Sun & Soul™ spa brings to your life.

To get you started, we've put together this comprehensive user manual. It contains important health and safety information you need to know when using a Sun & Soul™ spa pool. After reading this manual, you should know how to safely use, operate, and maintain your new spa.

Please take the time to read through this Owner's Manual. In it, you will find:

- guidelines on caring for your spa
- a complete explanation of the controls
- safety instructions
- a troubleshooting section
- ...and lots more

And don't worry, if there is anything you aren't sure of or need help with – please do not hesitate to contact your nearest Sun & Soul dealer for support. We are here to help!

Sincerely,  
The Sun & Soul Team.



# Important Information

---

## Important Spa Owner Information

Your Sun & Soul™ spa is constructed to the highest standards and is capable of providing many years of trouble-free use.

However, because heat retentive materials are used to insulate the spa for efficient operation, an uncovered spa surface and wall fittings directly exposed to sunlight and high temperatures for an extended period are subject to permanent damage or discolouration.

Damage caused by exposing the spa to this abuse is not covered under warranty. We recommend that you always keep the spa full of water when it is exposed to direct sunlight and that you keep the spa cover in place at all times when the spa is not in use.

**Please be aware that we are constantly striving for continuous improvement, therefore, modifications and enhancements may be made to our spas which affect the specifications, illustrations and/or instructions contained herein.**

\*Information is subject to change without notice.

**Sun & Soul – for the important things in life**

# Table of Contents

---

Safety Information & Warnings.....	7
Choosing a location.....	16
Equipment Location.....	20
Power Requirements.....	27
Start-up Procedure.....	28
Water Care.....	38
Spa Cover Installation.....	44
How to Drain Your Spa.....	48
Filter Cartridges.....	50
Winterise Your Spa.....	53
Equipotential Bonding .....	20
<b>SpaNet™ Controller Warnings</b>	
SpaNet™ SV Mini1 & SV Mini 2, SV2, SV3, Sv4.....	58
<b>Electrical Installation</b>	
SpaNet™ SV Mini1 & SV Mini 2, SV2, SV3, Sv4.....	62
<b>SpaNet™ SV Mini 1 &amp; SV Mini 2.....</b>	<b>70</b>
<b>Error Codes/ Troubleshooting</b>	
SpaNet™ SV Mini 1 & SV Mini 2.....	93
<b>SpaNet™ SV2, SV3 &amp; SV4.....</b>	<b>98</b>
<b>Error Codes/ Troubleshooting</b>	
SpaNet™ SV2, SV3 & SV4.....	148
SpaNet™ Product Warranty.....	154

# Table of Contents

---

## Optional Upgrade

WiFi & Audio Kit.....	156
Swim Pole (*Available on selected Swim spas and S&S models).....	203
Notes.....	204

## Seven steps to starting your spa:

1. Install cover and cover locks - page 44
2. Check Barrell unions are tight - page 28
3. Check drain valve is closed - page 30
4. Fill the spa - page 32
5. Power up spa - page 56
6. Set Water Temperature - page 76 for SV Mini1 & SV Mini2 models, and page 113 for SpaNet™ SV2, SV3 & SV4
7. Start-up Water Care - page 38

\*Information is subject to change without notice.

# Safety Information & Warnings

---

## Important Safety Instructions for all Spa Owners

### READ AND FOLLOW ALL INSTRUCTIONS CAREFULLY!

This spa was manufactured to meet the standards and specifications outlined in the AS 1926.3 water recirculation systems and AS 2610.2 Spa Pool - Private Spas. When installing and using this spa, basic safety precautions should always be followed, including:

#### 1. **DANGER: RISK OF SEVERE INJURY OR DROWNING!**

- Extreme caution must be exercised to prevent unauthorized access by children.
- To avoid accidents, ensure that children do not use this spa unless supervised at all times. Adult supervision is a critical safety factor in preventing children from drowning.
- Use the straps and tie downs to secure the spa cover when not in use. This will help discourage unsupervised children from entering the spa. Keep the spa cover secure in high-wind conditions.
- There is no representation that the cover, clip tie-downs, or actual locks will prevent access to the spa.

#### 2. **DANGER: RISK OF SEVERE INJURY OR DROWNING!**

- Keep hair, loose articles of clothing or hanging jewelry away from suction fittings, rotating jets or other moving components to avoid entrapment that could lead to drowning or severe injury.
- Never use the spa unless all suction guards, filter, filter lid, or skimmer assembly are installed to prevent body and/or hair entrapment.
- Never operate or use the spa if the filter, filter lid, or skimmer assembly are broken or any part of the skimmer assembly is missing. Please contact your dealer or nearest service center for service.
- The suction fittings and suction covers in this spa are sized to match the specific water flow created by the pump(s). If it is necessary to replace the suction fittings, suction covers or pump(s), be sure that the flow rates are compatible and are in compliance with the Australian Standard AS1926.3:2010.

# Safety Information & Warnings

---

- Never replace a suction fitting or suction cover with one rated less than the flow rate marked on the original suction fitting. Using improper suction fittings or suction covers can create a body or hair suction entrapment hazard that may lead to drowning or severe injury.

### 3. **DANGER: RISK OF SEVERE INJURY FROM ELECTRIC SHOCK OR DEATH FROM ELECTROCUTION. PRODUCT DAMAGE OR ELECTRICAL FIRE. (ALL Electrical work must be completed by a qualified Electrician as per local regulations).**

- Items containing live parts, except parts supplied with safety extra-low voltage not exceeding 12v, must be inaccessible to a person in the bath.
- Never permit any electrical appliance, such as a light, telephone, radio, television, etc. within 1.25m (arms reach) of a spa unless such appliances are built-in by the manufacturer.
- Never bring any electrical appliances into or near the spa.
- Never operate any electrical appliances from inside the spa or when you are wet.
- Any spa that requires an electrical service over 15amps must be connected by an electrician if being hardwired or using a plug. **No extension cords are to be used in conjunction with the operation of a spa.** Supplying power to the spa, which is not in accordance with these instructions, will void both the independent testing agency listing and the manufacturer's warranty.
- The electrical supply for this product must include a suitably rated isolating switch and circuit breaker to comply with local electrical regulations. This RCD/GFCI circuit breaker must be installed at the power supply in the house electrical box.
- For Australia/ New Zealand, the spa should be supplied through a residual current device (RCD) with a rated tripping current not exceeding 30mA (IEC 60335-2-60).

\*Information is subject to change without notice.



# Safety Information & Warnings

---

## 4. **WARNING: RISK OF SEVERE INJURY OR DEATH!**

- Extreme caution must be exercised to prevent diving or jumping into the spa or slipping and falling, which could result in unconsciousness, drowning, or serious injury. Remember that wet surfaces can be very slippery.
- Never stand, walk or sit on the top edge of the spa.

## 5. **WARNING: RISK OF HYPERTHERMIA (OVER-HEATING) CAUSING SEVERE INJURY, BURNS, WELTS OR DEATH!**

- Water temperature in excess of 40°C (104°F) may be injurious to your health.
- Refer to page 19 in this manual, Hyperthermia for specific causes and symptoms of this condition.
- The water in the spa should never exceed 40°C (104°F). Water temperatures between 38°C (100°F) and 40°C (104°F) are considered safe for a healthy adult.
- Lower water temperatures are recommended for young children (children are especially sensitive to hot water) and when spa use may exceed 10 minutes.
- In order to avoid the possibility of hyperthermia (Heat Stress) occurring it is recommended that the average temperature of the spa-pool water should not exceed 40°C.
- Always test the spa water temperature before entering the spa. The user should measure the water temperature with an accurate thermometer since the tolerance of water temperature-regulating devices may vary as much as +/- 2°C (5°F).

## 6. **WARNING: RISK OF SEVERE INJURY OR DEATH!**

- Since excessive water temperatures have a high potential for causing fetal damage during the early months of pregnancy, if pregnant or possibly pregnant, consult your physician before using a spa.
- Pregnant or possibly pregnant women should limit spa water temperatures to 38°C (100°F).
- Persons suffering from obesity or a medical history of heart disease, low or high blood pressure, circulatory system problems, diabetes, infectious diseases or immune deficiency syndromes should consult a physician before using a spa.

# Safety Information & Warnings

---

- If you experience breathing difficulties in association with using or operating your spa, discontinue use and consult your physician.
- Persons using medication should consult a physician before using a spa since some medication may induce drowsiness, while other medication may affect heart rate, blood pressure, and circulation.
- Persons suffering from any condition requiring medical treatment, the elderly, or infants should consult with a physician before using a spa.
- The use of alcohol, drugs, or medication before or during spa use may lead to unconsciousness with the possibility of drowning.

## 7. **WARNING: RISK OF SEVERE INJURY OR DEATH!**

- Prolonged immersion in a spa may be injurious to your health.
- Observe a reasonable time limit when using the spa. Exposures at higher temperatures can cause high body temperature (over-heating). Symptoms may include dizziness, nausea, fainting, drowsiness, and reduced awareness. These effects could possibly result in drowning or serious injury.
- Never use a spa immediately following strenuous exercise. Enter and exit the spa slowly. Wet surfaces can be slippery.

## 8. **WARNING: TO DECREASE RISK OF INFECTION OR DISEASE!**

- To reduce the risk of contracting a waterborne illness (e.g. an infection, bacteria or virus) and/or respiratory ailments, maintain water chemistry within the parameters listed on the chemical container label. Guidelines are listed on page 139 of this manual and consult with a licensed engineer regarding proper ventilation if installed indoors or in an enclosed area.
- People with infectious diseases should not use a spa to avoid water contamination, which could result in spreading infections to others.
- Always shower before and after using your spa. Maintain water chemistry in accordance with chemical manufacturer's instructions. Failure to do so may result in contracting a waterborne illness (e.g. an infection, bacteria or virus).

\*Information is subject to change without notice.

# Safety Information & Warnings

---

## 9. **WARNING: RISK OF SEVERE INJURY OR DEATH!**

The appliance is not intended for use by persons (including children) with reduced physical, sensory or mental capabilities, or lack of experience or knowledge, unless they have been given supervision or instruction concerning use of the appliance by a person responsible for their safety.

## 10. **WARNING - VENTILATION.**

In addition to maintenance of filters and water chemistry, proper ventilation is recommended to reduce the risk of contracting a waterborne illness (e.g. an infection, bacteria or virus) and/or respiratory ailments that could be present in the air or water. Consult a licensed architect or building contractor to determine your specific needs if installing your hot tub indoors.

## 11. **CAUTION: TO DECREASE RISK OF PRODUCT DAMAGE.**

- Maintain water chemistry in accordance with the chemical manufacturer's instructions.
- Proper chemical maintenance of spa water is necessary to maintain safe water and prevent possible damage to spa components.
- If you do not intend to use your spa, or if there is a prolonged power outage during periods of severe freezing temperatures, it is important that all water be removed from the spa and equipment to protect against damage from freezing.

## 12. **NOTE:**

This spa is not intended nor designed to be used in a commercial or public application. The spa buyer shall determine whether there are any code restrictions on the use or installation of this spa since local code requirements vary from one locality to another.

# Entrapment Risk

## **DANGER** RISK OF PERSONAL INJURY OR DEATH!

Never operate the spa if a suction fitting, suction cover, filter, filter lid or skimmer assembly are broken, damaged or missing.

Suction Fittings,  
Suction Covers  
(locations vary  
by models)

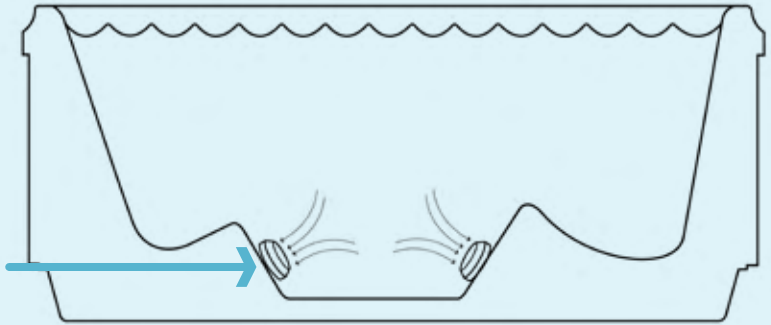

**Note:** Suction covers must be replaced every 7 years.

\*Information is subject to change without notice.

1. **DANGER: RISK OF SEVERE INJURY OR DROWNING! Hair entrapment:**

May occur if hair is entangled, knotted or snagged in a drain suction or skimmer assembly. This has been reported in persons who, when they submerged themselves underwater, allowed hair to come close and/or within the reach of the suction fittings, suction covers or skimmer assembly.

- Keep hair away from suction fittings, suction covers, filter, filter lid or skimmer assembly.
- Children are at risk for hair entrapment if swimming underwater.
- Never allow children to play or get near the suction fittings, suction covers, filter, filter lid or skimmer assembly.

2. **DANGER: RISK OF SEVERE INJURY OR DROWNING! Limb entrapment:**

May occur when a limb becomes entrapped, inserted or sucked into a suction or outlet opening.

- Always keep suction fittings, suction covers, filter, filter lid or skimmer assembly in place when operating to avoid limb entrapment.
- Never allow children to play or get near the suction fittings, suction covers, filter, filter lid or skimmer assembly.

3. **DANGER: RISK OF SEVERE INJURY OR DROWNING! Body entrapment:**

May occur when part of the torso becomes entrapped, inserted or sucked into a suction or outlet opening.

- Never allow children to play or get near the suction fittings, suction covers, filter, filter lid or skimmer assembly.

# Entrapment Risk

---

## 4. **DANGER: RISK OF SEVERE INJURY OR DROWNING! Evisceration (disembowelment) entrapment:**

- May occur when the buttocks becomes entrapped, inserted or sucked into a suction or outlet opening.
- Never sit on suction fittings, suction covers, filter, filter lid or skimmer assembly.
- Never allow children to play or get near the suction fittings, suction covers, filter, filter lid or skimmer assembly.

## 5. **DANGER: RISK OF SEVERE INJURY OR DROWNING! Mechanical entrapment:**

May occur when jewelry, swimsuit, or hair accessories become entangled, knotted or snagged in a drain suction or skimmer assembly.

- Never allow your jewelry, swimsuit, or hair accessories to come close to the suction fittings, suction covers or skimmer assembly.
- Never allow children to play or get near the suction fittings, suction covers, filter, filter lid or skimmer assembly.
- An emergency stop switch controlling all spa pool pumps, blowers and heaters shall be provided within 3.0m of the spa pool and shall be visible at all times.
- As per SPASA compliance guide, Industry accepted best practice for emergency stop switches may include an electrical switch, isolator switch or any other emergency stop switch control measure.

\*Information is subject to change without notice.

# Hyperthermia

---

Prolonged immersion in hot water may induce hyperthermia (over- heating). The use of alcohol or drugs can greatly increase the risk of fatal hyperthermia in spas. A description of the causes, symptoms, and effects of hyperthermia are as follows:

Hyperthermia occurs when the internal temperature of the body reaches a level several degrees above the normal body temperature of 37°C . The symptoms of hyperthermia include drowsiness, lethargy (fatigue), and an increase in the internal temperature of the body (feeling of being too hot). The effects of hyperthermia include:

- Unawareness of impending hazard;
- Failure to perceive heat;
- Failure to recognize the need to exit spa;
- Physical inability to exit spa;
- Fetal damage in pregnant women; and
- Unconsciousness and danger of drowning.

# Choosing a Location

## General Considerations

The spa must be installed in such a manner as to provide drainage away from it. Placing the spa in a depression without provisions for proper drainage could allow rain, overflow, leaks from spa plumbing, and other casual water to flood the equipment and create a wet condition in which it would sit. This is not covered under warranty.

When installing spas below ground or recessing a spa into a floor or deck, make sure the equipment can still be easily accessed for servicing.

There should be no obstructions that would prevent access to jet components or the removal of cabinet panels, especially on the side with the equipment bay.



\*Information is subject to change without notice.



# Choosing a Location

## Outdoor

---

### Outdoor Location

In selecting the ideal outdoor location for your spa, we suggest that you take into consideration:

- The proximity to changing area and shelter (especially in colder weather).
- The pathway to and from your spa (this should be free of debris so that dirt and leaves are not easily tracked into the spa). The closeness to trees and shrubbery (remember that leaves and birds could create extra work in keeping the spa clean).
- A sheltered environment (less wind and weather exposure can result in lowered operation and maintenance costs).
- The overall enhancement of your environment. It is preferable not to place the spa under an unguttered roof overhang since run-off water will shorten the life expectancy of the spa cover.
- For spas that are to rest on balconies, roofs or other platforms not specifically tied into main structural support, consult a professional Structural Engineer with experience in this type of application.
- In the unlikely event that you should ever need to access or gain entry to any portion of the spa for servicing, it is highly recommended that you plan your outdoor installation to provide full access to the entire spa. Please take this into consideration when placing the spa in a deck or enclosed by a surrounding.
- Consider locating your spa away from any reflective surface or glass to prevent any damage to the synthetic cabinet.
- Do not shim the spa. To ensure proper support the spa must sit flat on the intended foundation.

# Choosing a Location

## Indoor

---

### Indoor Location

For indoor installations many factors need to be considered before installing a spa indoors:

- **Proper Foundation:** Consult a Structural Engineer when considering a foundation that will adequately support the spa the entire time it is in place.

Proper support is critical especially if the spa is to rest on a second story or higher. For spas that are to rest on balconies, roofs or other platforms not specifically tied into the main structural support, you should consult a professional Structural Engineer with experience in this type of application.

- **Proper Drainage:** It is extremely important to have in place measures to sufficiently handle excessive water spillage. Be sure the flooring in which the spa rests on has adequate drainage and can handle the entire contents of the spa. Be sure to make provisions for ceilings and other structures that may be below the spas installation. Areas around your spa can become wet or moist so all flooring and subsequent furniture, walls and adjacent structures should be able to withstand or resist water and moisture.

- **Proper Ventilation:** Proper ventilation should be discussed with an Engineer or authority competent enough to understand the necessary provisions needed to vent moist or heated air and air associated with chemical odors outdoors. When the spa is in use, considerable amounts of moisture will escape, potentially causing mould and mildew over time, which can damage certain surfaces and/ or surroundings.

- **Sufficient Access:** In the unlikely event that you should ever need to access or gain entry to any portion of the spa for servicing, it is highly recommended that you plan your indoor installation to provide full access to the entire spa.

# Choosing a Location

## Indoor

---

- **Warranty:** Damage caused by not following these guidelines or any improper installation not in accordance to local codes or authorities is not covered under the spas warranty. Please consult your local state or city building ordinances.
- **Do not shim the spa.** To ensure proper support the spa must sit flat on the intended foundation.

**CAUTION:** *If the spa is indoors or located in an enclosed area, proper ventilation should be discussed with an Engineer an or authority competent enough to understand the necessary provisions needed to vent moist or heated air and air associated with chemical odors outdoors. When the spa is in use considerable amounts of moisture will escape potentially causing mold and mildew. This can cause health risk. Over time, this can damage certain surfaces, surroundings, and equipment.*

# Equipment Location

## SOUL100™

### Colour code equipment

Equipment Bay

Drain Valve

Circulation Pump

Keypad

Boost Pump

Heater

Conduit Access

Subwoofer

### SOUL100™

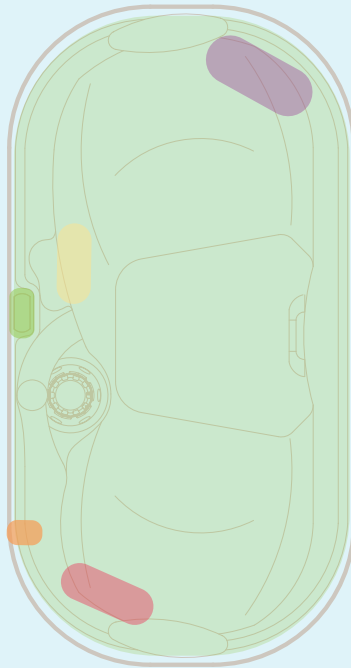

\*\*WiFi & Audio Kit optional upgrade is not available in this model.

\*Information is subject to change without notice.

# Equipment Location

## SOUL200™ & SOUL300™

### SOUL200™



\*\*WiFi & Audio Kit optional upgrade is not available in this model.

### SOUL300™

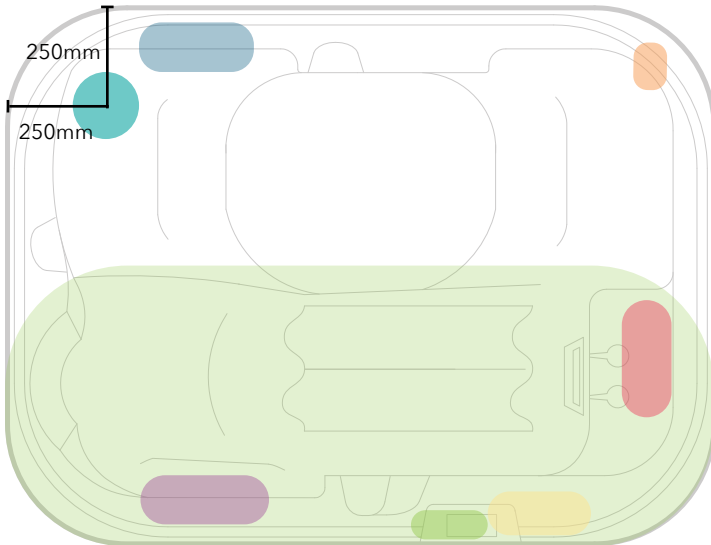

\*Information is subject to change without notice.

# Equipment Location

## SOUL500™ & SOUL500SE™

SOUL500™

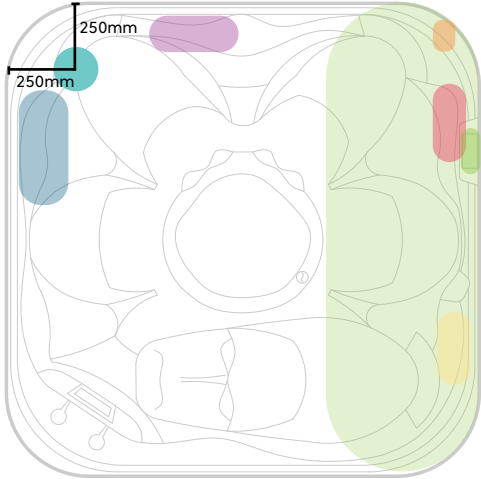

SOUL500SE™

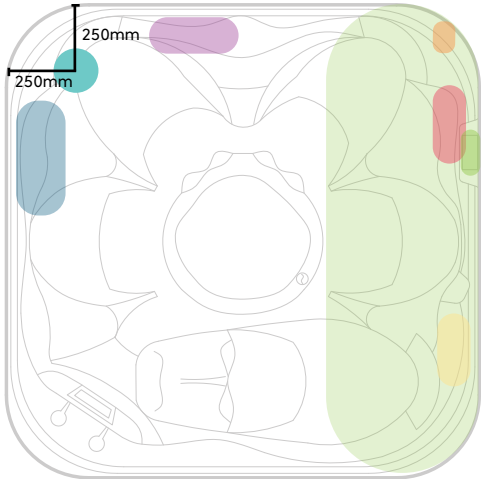

\*Information is subject to change without notice.

# Equipment Location

## SOUL550™ & SOUL600™

### SOUL550™

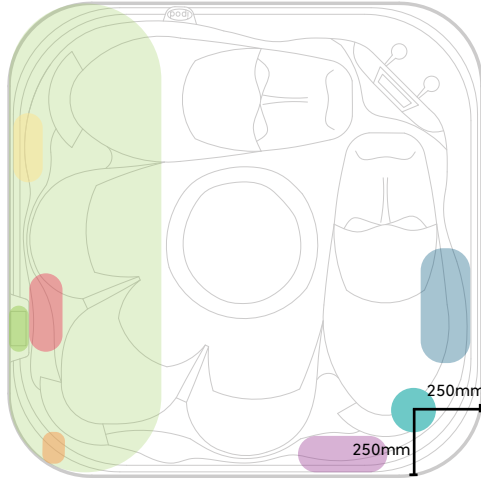

### SOUL600™

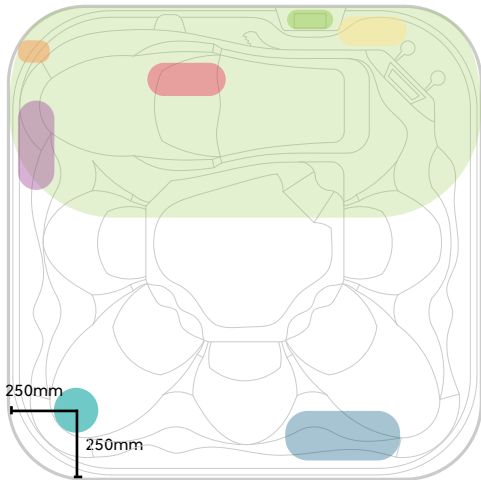

\*Information is subject to change without notice.

# Equipment Location

## SOUL700™ & SOUL800™

---

### SOUL700™

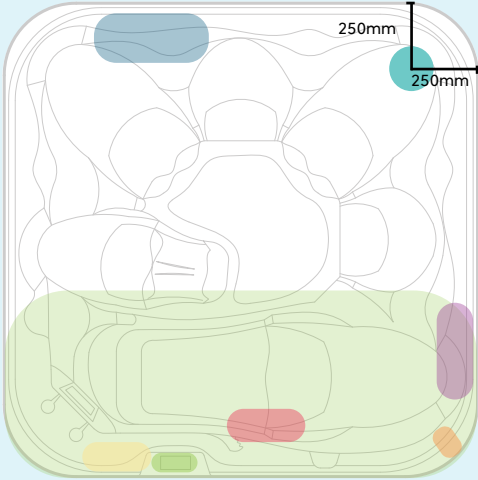

### SOUL800™

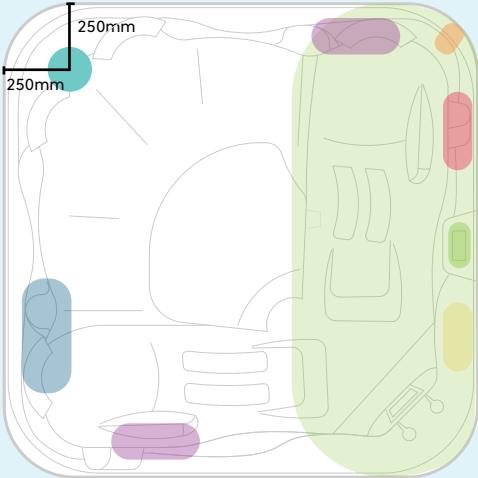

\*Information is subject to change without notice.



# Equipment Location

## SOUL3900™ & SOUL4000™

### SOUL3900™

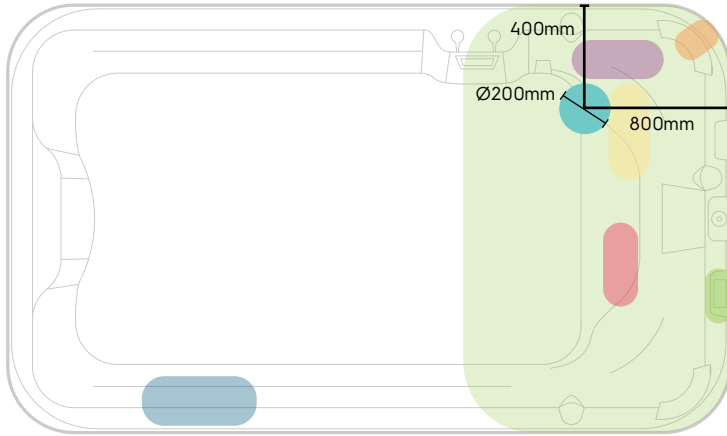

### SOUL4000™

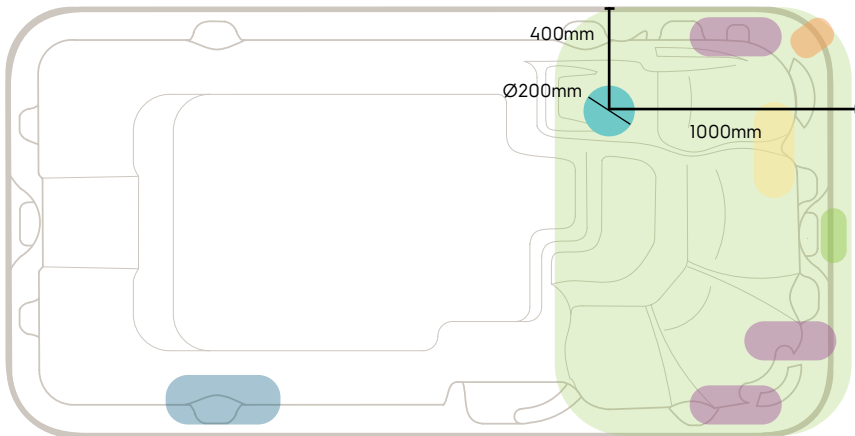









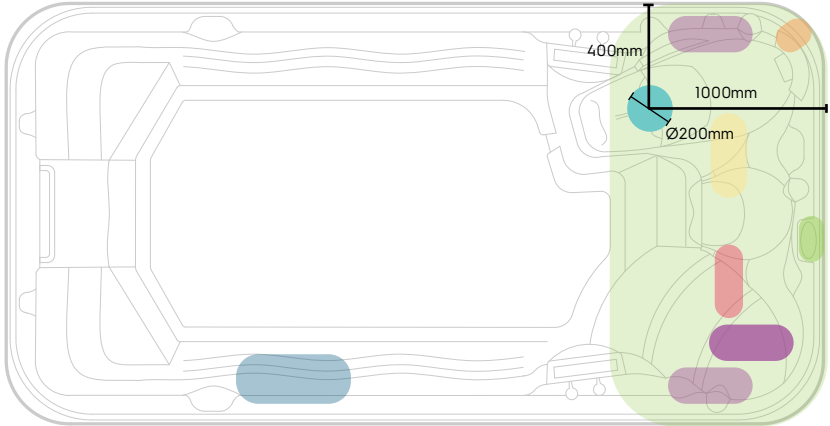

\*Information is subject to change without notice.

# Equipment Location

## SOUL4500™

SOUL4500™



 Equipment Bay	 Drain Valve	 Circulation Pump
 Keypad	 Boost Pump	 Heater
 Conduit Access	 Extra Boost Pump	 Subwoofer

\*Information is subject to change without notice.

# Power Requirements

## Recommended power requirement

Spa Model	Electrical Requirement	Controller
SOUL100™	10 Amps*	SVM1
SOUL200™	10 Amps*	SVM1
SOUL300™	10 Amps*	SVM1
SOUL500™	15 Amps	SVM2
SOUL500SE™	10 Amps*	SVM1
SOUL550™	15 Amps	SVM2
SOUL600™	15 Amps	SVM2
SOUL700™	15 Amps	SVM2
SOUL800™	25 Amps	SVM2
SOUL3900™	10 Amps*	SVM1
SOUL4000™	32 Amps	SV3
SOUL4500™	32 Amps	SV3

\*Check with an electrician about dedicated circuit requirements.

# Start-up Procedure

## Check Barrel Unions

---

### 1. Check barrel unions are tight.

Remove spa cabinet side panel (on key pad side) to access equipment bay. See page 20 to locate your spa equipment bay.

Barrel unions are the connections between the pumps and heater and the plumbing of the spa. If they become loose, this can cause water loss. It is important to check the tightness of these unions periodically, and especially when spa is first delivered. The unions are designed to be retightened by hand. Rotate the locking nut clockwise to tighten.



Check barrel unions



Only tighten the barrel union by hand

**NOTE:** *If you see water escaping from beneath your spa, the barrel unions should be the first thing you check. LEAKS FROM BARREL UNIONS ARE NOT COVERED BY THE SPA'S WARRANTY.*

\*Information is subject to change without notice.

# Start-up Procedure

## Check Isolation Valves

### 2. Check isolation valves are open.

T-handle, isolation valves, enable the water flow to be closed to allow removal of spa equipment for servicing without the need to empty the spa. The isolation valve T handles must be pulled UP to be OPEN and allow water flow.



T-handle valves Open

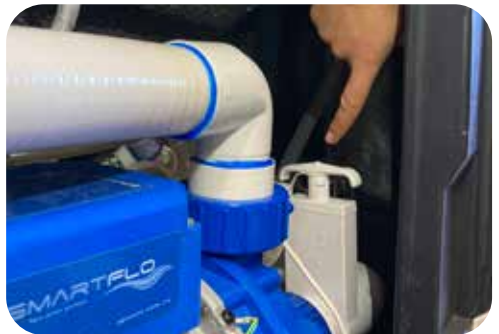

T-handle valves Closed

# Start-up Procedure

## Check Drain Valve

### 3. Check that the drain valve is closed and firmly tightened

To find the drain valve check page 20 for equipment location



If it is open, twist and press in the drain cap.



Tighten the cap. Close drain valve.

\*Information is subject to change without notice.

# Start-up Procedure

## Check Jets

---

### 4. Check all jets are open.

Water flow to most jets can be turned on or off by rotating the jet face clockwise (on) or anti-clockwise (off). Check to ensure all jets are open before filling with water.



# Filling Your Spa Pool

## Spa fill up procedure

For best results, read each step in its entirety before proceeding with this procedure. Make sure the drain is closed before you begin, page 30.

### 1. Prepare the spa for filling

- Clear all debris from the spa. (Although the spa shell has been polished at the factory, you may want to treat it with a specially formulated spa cleaner.) Consult your authorized Sun & Soul™ dealer for additional information prior to filling spa.
- If using the primary filter inlet to fill, remove the filter cover, then remove the filter cartridge as outlined in the next page.

### 2. Fill spa

Fill your spa from a source of clean water such as domestic tap water or rainwater, DO NOT OVERFILL your spa. Fill until the water comes up to the fill line on the filter face. Do not let the water fill to the point of touching the bottom of the lowest headrest.

- 2.1. Remove one of the spa filters. To remove the filters you need to twist the filter clockwise - to install the filters, you push down while twisting the filters counter-clockwise. See the following pages.
- 2.2. Remove any fitting from the end of your garden hose that might come off or stop the hose end from fitting down the hole where the filter that you have removed is located.
- 2.3. Insert the end of your garden hose, no more than 250mm into the hole where the filter was placed. We do not recommend filling the spa by placing the hose into the foot well of the spa because it can create an air bubble in the plumbing system that can cause an error when starting up. See ER-3 in the troubleshooting section, check water prime page 94 for SpaNet™ SV Mini™ models and page 149 for SpaNet™ SV2, SV3 and SV4 models.

\*Information is subject to change without notice.



# Filling Your Spa Pool

## Single Filter

2.4. Turn on the water

2.5. Fill until the water reaches the fill line on the filter face.

### Single filter



Filter face, unscrew the fitting.

Not all models have screws. If your model does, remove the screw by turning counter clockwise

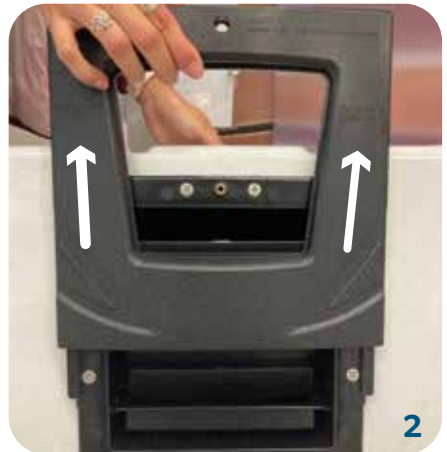

Remove spa filter face

# Filling Your Spa Pool Single Filter

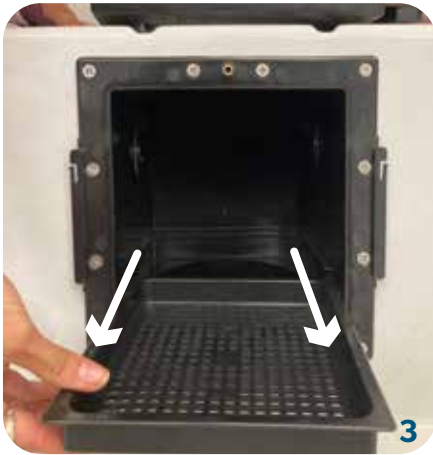

Remove the leaf catcher



Remove the filter counter-clockwise



Remove the pleated filter

\*Information is subject to change without notice.

# Filling Your Spa Pool Single Filter



Insert hose down inlet no more than 250mm



Fill with water until it reaches the fill line

# Filling Your Spa Pool

## Two Filters



Filter face, unscrew the fitting



Remove the spa filter face



Remove the leaf catcher

\*Information is subject to change without notice.

# Filling Your Spa Pool Two Filters



Remove one of the two filters counter-clockwise



Insert the end of the hose into the filter pipe



Fill with water until it reaches the fill line

# Water Care

## Warnings

---

### **WARNING**

Not following this guide can damage components in your spa and this damage is not covered under warranty.

Do not turn on the jet pumps or clean cycle for at least 30 minutes after you have added the sanitiser.

**TO DECREASE RISK OF INFECTION OR DISEASE!** Always maintain your spa filter as outlined below to ensure healthy spa water. Refer to pages 50 for additional information.

#### **Required filter maintenance**

Your new spa is equipped with an advanced water filtration system that provides unsurpassed water quality! To ensure maximum water quality at all times, you should clean the filter cartridges each month, or as necessary. See page 52 for filter cartridge cleaning instructions.

#### **Required water replacement**

**TO DECREASE RISK OF INFECTION OR DISEASE!** As a guide, spa water should be changed every 3-6 months for portable spas and 12-18 months for swim spas; or as needed, depending on factors including the number of spa users and hygiene. You will know it is time for a change when you cannot control foaming and/or you can no longer get the normal feel or sparkle to the water, even though the key water balance measurements are all within the proper parameters.

**ALWAYS FOLLOW THE SAFETY, USAGE AND STORAGE INSTRUCTIONS FOUND ON THE CHEMICAL CONTAINER LABEL.**

\*Information is subject to change without notice.

# Water Care

## Healthy Spa Water Parameters

---

Always maintain your spa's water chemistry within the following parameters:

PH	7.5 - 7.8
Free Chlorine	2.0 - 3.0mg/L
Free Bromine	4.0 - 6.0mg/L
Total Alkalinity	80 - 200mg/L
Calcium Hardness	150 - 250mg/L
Hydrogen Peroxide	100 - 150mg/L

# Water Care

## Spa Chlorine Dosage per Model

---

Spa Model	Water Capacity (litres)	Maintenance Dosage (grams per day of Spa Chlorine)	Shock Dosage (grams per day of Spa Chlorine)
SOUL100™	450	3	11
SOUL200™	519	3	13
SOUL300™	880	5	22
SOUL500™	1097	7	27
SOUL500SE™	1097	7	27
SOUL550™	1030	6	26
SOUL600™	1230	7	31
SOUL700™	1450	9	36
SOUL800™	1380	8	35
SOUL3900™	5586	33	140
SOUL4000™	5700	34	143
SOUL4500™	6120	37	153

\*Information is subject to change without notice.



### Add start-up chemicals

Once the spa water has reached your desired temperature, use the test strips to measure pH and Alkalinity. See page 39 for the correct pH and Alkalinity levels. Wait at least 20 minutes after applying any balancer chemicals before testing again.

#### If PH is out of balance:

- If the PH is too LOW, add alkalinity increaser (alkalinity up).
- If the PH is too HIGH, add PH decreaser (PH down).

#### If Alkalinity out of balance:

- If the alkalinity is too LOW, add alkalinity increaser (alkalinity up).
- If the alkalinity is too HIGH, add PH decreaser (PH down).

### Sanitise your spa water

Once your spa water is balanced, sanitise your spa with Spa Chlorine. Use a start-up shock dose of 25 grams per 1,000 litres of spa water. See the sanitiser container label for the specific dosing instructions. Obtain your spa litreage from the table on page 40.

**IMPORTANT:** *Do not turn on jet pumps for at least 30min after sanitising your spa. Leave spa cover open while sanitising or shocking your spa*

# Water Care

## Regular Chemical Maintenance

---

Following the instructions on the sanitiser container label, dose your spa with Spa Chlorine see table in page 40.

In the event of heavy spa use or water clarity issues, a shock dose of 25 grams per 1,000 litres of spa water can be used. See the chemical product label for the specific dosing instructions.

**Do not use the test strips to monitor chlorine levels.** Use the daily dosing instructions on the back of the chlorine container instead. Failure to follow this can result in damage to your spa or unsafe conditions.

### **Recommended weekly maintenance:**

- Step 1.** To test the water is balanced, use a test strip following the instructions on the back of the test strip container.
- Step 2.** Adjust pH, alkalinity and total hardness.
- Step 3.** Remove and rinse your pleated filters.

### **Recommended monthly maintenance:**

- Step 1.** Remove and clean your pleated cartridge filters using Cartridge Cleaner solution by following the instructions on the container.

**Tip:** If your water is cloudy, clean your filters more frequently.

\*Information is subject to change without notice.

# Water Care

## Regular Chemical Maintenance

---

### Recommended 3 - 6 monthly maintenance:

As a guide, spa water should be changed every 3-6 months for portable spas and 12-18 months for swim spas; or as needed, depending on factors including the number of spa users and hygiene.

**Step 1.** Drain your spa by following the draining procedure in page 147. Be sure to rinse and wipe down surfaces.

**Step 2.** Restart by following the start guide.

Pleated filters should be replaced every 12 - 18 months.

**IMPORTANT:** *Follow dosage and safety instructions on chemical containers. The use of poor quality chemicals can lead to damage not covered by your spa warranty. Mix sanitiser in a bucket of spa water before adding to your spa. Don't risk damage to your spa.*

## **CAUTION** Do not use test strips to monitor chlorine levels.

Use the daily dosing instructions on the back of the chlorine container instead.

Failure to follow this can result in damage to your spa or unsafe conditions. Always pre-mix the chlorine with water in a bucket before adding it to the spa water.

# Spa Cover Installation

## Place cover on spa

- Keeping the insulating cover in place anytime the spa is not in use will reduce the time required for heating, thereby minimizing operating costs.
- The time required for initial heat-up will vary depending on the starting water ambient temperature and your desired temperature set point.
- While the spa is filling you can attach the cover locks. Cover locks are a small but important safety feature that prevents the spa from being accessed by children and the cover from blowing off in normal conditions. If you live in a high wind environment we recommend purchasing an optional “Hurricane Strap” for your spa cover.

## Cover locks position

The corner cover latches are the only latches installed at the factory so that the owner can determine which way the cover is going to be installed and place the remaining latches correctly. The other latches can be found in the spa welcome kit included with the spa.

1. First determine which way you want the cover hinge to be located. This will depend on your unique installation location.
2. Click all the pre-installed cover locks into place
3. You should not be able to fit an object greater than 100mm between the lip of the spa and the cover, when the cover is closed and latched into place.
4. All of the cover locks need to be installed

## Tools and Parts Needed:



\*Information is subject to change without notice.

# Spa Cover Installation

## Assembly process

1. Get the cover lock and attach it to the latch. Make the strap taugt and loosen slightly to get the strap in the correct position.
2. Holding the strap in place, use a marker to mark the side and bottom of the latch with a line. Then, remove.
3. Unclip the latch and place the lock over the marks. Draw three holes: one on each side and one above. Pre drill holes on the cabinet mark using a 2mm drill bit.
4. Attached the lock to the cabinet, screwing it into place. Test the latch.
5. Repeat all the steps above on the remaining three centre latches.



Get the strap and cover lock into position



Mark the lock position on the cabinet

# Spa Cover Installation



Drill the holes on the marked position



Screw lock into place on the cabinet



Test the latch and repeat steps

\*Information is subject to change without notice.

# How to Drain Your Spa

As a guide, spa water should be changed every 3-6 months for portable spas and 12-18 months for swim spas; or as needed, depending on factors including the number of spa users and hygiene. To drain your spa, power must be disconnected at the circuit breaker. Locate the drain inside at the bottom end of the spa cabinet. To find the drain valve position please check your spa model tech pack for equipment location or see page 20 in this manual.

You must follow your local council for guidelines for spa water disposal. We recommend that you stop adding chemicals to your spa 48 hours prior to draining your spa and to not sit in your spa during this time. This will allow residual sanitiser to dissipate from the spa water prior to dumping the water.

**NOTE:** *The drain will not remove all of the water in the spa. You may have to remove a small amount of water by hand.*

## Steps:



To drain, spa power must be disconnected.

# How to Drain Your Spa



Locate the drain valve at the bottom end of the spa cabinet.



Twist the cap and pull it midway out



Remove the cap



Replace the cap with the hose nozzle and twist until it is hand tight

**NOTE:** *Your spa comes with a specialized hose adapter. Unfortunately, it can't be purchased at any local hardware store. So please make sure not to lose it.*

\*Information is subject to change without notice.



# How to Drain Your Spa

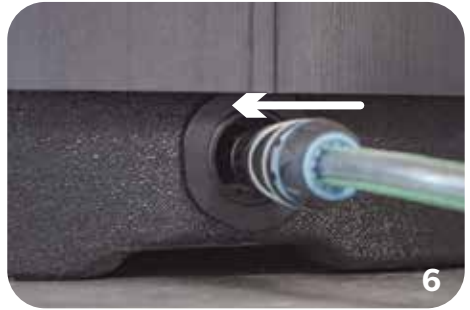

Attach the hose to the nozzle



When you are ready to drain your spa; pull out to extend the drain valve



To activate the draining process. Give the valve a quarter turn and fully extend the open position



Drain your spa into an appropriate area

# Filter Cartridges

Most spas are equipped with one, two or four filter cartridges (depending on the spa model).

- All the Sun & Soul™ spas use a 205 x 170mm Spa pool filter 125488.



- Only the SOUL100™ and SOUL200™ spas use a 235 x 125mm FC-FAA231.



\*Information is subject to change without notice.

# Filter Cartridges

---

**NOTE:** *Filter cartridges may require replacement or cleaning more frequently depending on user hygiene, length and frequency of regular spa use.*

## Removing filters:

To remove the filters simply unscrew the cartridge in an anti-clockwise direction and pull out from spa pool.

## Reinstalling filters:

When reinstalling filters first hold the cartridge underwater until the air stops bubbling (at this point most of the air has been removed from the cartridge). Then screw the cartridge back into place in a clockwise direction.

**NOTE:** *DO NOT screw the cartridge back into place excessively tight. Only screw the cartridge until it no longer spins freely. The suction from the pumps will put the cartridges in further once operated. If the cartridge is screwed in place excessively tight before pump operation, the cartridge may be difficult to remove or could even cause the filter thread connection to twist or break the next time the cartridge is removed. This breakage is not covered by warranty.*

# How to Clean Your Filter Cartridges

**Step 1.** Remove the filter from the spa. See page 51.

**Step 2.** Using a hose, first rinse off all large particles.

We recommend doing this weekly or as needed.



**Step 3.** Monthly or as needed, we recommend soaking your filters for 24 hours in a spa filter cartridge cleaner. Follow the dosing instruction on the label of the filter cartridge cleaner.



**Step 4.** After your filters have soaked for 24 hours remove them from the solution, rinse them off with a filter cleaning wand, and set them out to dry.

\*Information is subject to change without notice.

# Winterise Your Spa

---

It seems crazy not to soak in your spa during the cold winter months! But maybe you are going away for the colder months or just taking a break from using your spa pool or swim spa?

Whatever the reason, correctly winterizing your spa can save you time and money when you are ready to use it again.

Keep in mind, we strongly recommend that you never leave your spa empty for a period of 2 weeks or more. Leaving your spa empty can cause damage to the pumps, heater element, and shell. In most cases, you are better off turning the temperature of your spa down to the minimum setting and maintaining your PH & Alkalinity levels to ensure they stay within recommended readings.

If for some reason you need to empty your spa for a period longer than 2 weeks we recommend the following steps;

## SPECIAL NOTES:

- *If you live in an area prone to freezing you will want to take extra care in ensuring that all of the water is removed from your spa.*
- *If at any time you feel uncomfortable with the steps below, contacting a professional spa technician is a great idea.*

## Products to empty and winterize your spa or swim spa

1. Pipe Degreaser / Cleaner
2. Filter Cleaner
3. Vinyl Cleaner
4. Vinyl protectant
5. Sponge or wet and dry vac (Optional but easier)

# Winterise Your Spa

## Step 1. Clean the pipes and inner surfaces

We recommend using a **spa pipe degreaser** to circulate through your spa system. Follow the dosing instructions on the label and circulate the pipe cleaner for the prescribed amount of time. This will clean the internal surfaces of the spa plumbing and equipment.



## Step 2. Make certain the power to your spa is disconnected

Remove the fuse or turn off the main circuit breaker to disconnect power to your spa.

## Step 3. Remove the drain cap on your spa and drain the water

Follow the manufacturer's instructions to ensure you use the correct process for your spa. Read our detailed instructions on how to drain your spa water in page 48 on this manual.

## Step 4. Loosen fittings on your spa plumbing

Once the spa is empty, open the cabinet door to gain access to your controller and all pumps. Undo the barrel unions that connect the plumbing to the spa controller, heater and pumps. Undoing these unions will allow any excess water in the pipework of the spa to be drained. Without following this process stagnant water will sit in the pipework and cause damage to the seals in your pumps, your heater element, and control sensors. See page 28 for more information about barrel unions.

\*Information is subject to change without notice.

# Winterise Your Spa

---

## Step 5. Purge water from the pipes and shell

Many people will use a wet and dry vac to either suck or blow the remaining water from the pipes. This is more critical if you are in a colder climate. Use a sponge or the wet and dry vac to remove remaining water from the foot well, seats and filter well.

Once the spa pipework is empty of water, carefully re-connect and tighten the unions ensuring that the O-ring seal is seated correctly.

## Step 6. Clean the spa shell

This is a perfect time to clean the spa shell. We recommend using pipe cleaner on a non-scratch sponge to clean the shell surface. You can use white vinegar, diluted with water by 50%, to remove any white calcium lines.



The key is to use very little water in the cleaning process so there is less to remove. Dry the shell with a soft towel. Our recommendation is to leave the cover off for a period of time to allow the shell to dry. (As per warning instructions on the shell, do not expose the acrylic shell to direct sunlight for extended periods of time)

# Equipotential Bonding

## **IMPORTANT: Read and follow ALL instructions.**

When using this electrical equipment, basic safety precautions should always be followed, including the following:

### **What is equipotential bonding?**

Equipotential bonding, commonly known as bonding, is a crucial electrical procedure that reduces the risk of personal injury and damage to equipment. The process works by connecting exposed parts to an earthing system (also known as a grounding system).

### **What is the purpose of equipotential bonding?**

The main purpose of equipotential bonding is to safely protect the user of the product from electric shock and damage to equipment as a result of an electrical fault.

In the case of a spa user, equipotential bonding will protect the swimmer from being injured by an electrical fault with the spa.

### **Do I require equipotential bonding?**

According to the Australian and New Zealand Standards (AS/NZS 3000: 2018 Electrical Installations), you will need your product to be equipotentially bonded if the product has a conductive metallic surface that is greater than 100mm in any dimension and the product is installed within arms reach (1.25m) of a body of water, including but not limited to spa pools, swim spas or pools. These standards are commonly known as Wiring Rules.

### **What objects need equipotential bonding?**

Objects that need equipotential bonding are any conductive metals greater than 100mm in any dimension and within arms reach of the spa pool. These may include but are not limited to cover lifters, grab rails, pool safety barriers, ladders, spa steps, pergolas, gazebos and umbrellas.

\*Information is subject to change without notice.



# Equipotential Bonding

---

## Who does equipotential bonding?

A licensed electrician must carry out the equipotential bonding work. If you are the owner of the product that requires equipotential bonding, you are responsible for ensuring the product complies with the requirements, at your own expense.

## Electrical wiring (Terminal Block Connections)

AUS/NZ/European Models (230-240V AC)

**Tools Required:** Wire Strippers, Phillips head screwdriver, flat head screwdriver.

1. Remove five (5) x Phillips screws from mains lid to access terminal block.
2. Cut away appropriate length of outer insulation from mains power cable and strip away 25mm (1") of wire insulation from the end of each wire.
3. Route mains cable through one of the two snap out holes provided and secure the cable with a gland to provide adequate cable strain relief (Tighten gland with use of a tool to ensure supply line anchorage point cannot be removed by hand).
4. Push the wires into the correct terminals as labelled. Refer wiring guide below or on the sticker inside the terminal block area.
5. Tighten all screws on the terminal block with a screwdriver and check to ensure each wire has been firmly secured. Then screw mains lid back on.

# SpaNet™ Controller Warnings

## SV Mini 1, SV Mini 2, SV2, SV3 & SV4

---

### **WARNING: RISK OF ELECTRICAL SHOCK**

Please read the following before installing or connecting this appliance.

- All electrical connections must be performed by a licensed electrician and must confirm to all national, state and local electrical codes in effect at the time of installation.
- The appliance should be supplied through a residual current device (RCD) having a rated residual operating current not exceeding 30mA.
- The appliance must be connected to a suitable rated and weather protected power supply. The supply line should be a dedicated power circuit and means for disconnection must be incorporated in the fixed wiring in accordance with your local wiring regulations. Means for disconnection from the supply mains should have a contact separation in all poles that provide full disconnection under over voltage Category III conditions.
- Earthed appliances must be permanently connected to fixed wiring (European models only).
- The appliance contains no serviceable parts. Do not attempt service of this control pack. Contact your dealer or authorised service agent for assistance.
- Turn the mains power OFF before servicing appliance or modifying any cable connection.
- Suitable for indoor use only or when installed under a weatherproof spa skirt. The appliance should be installed in an enclosure such that all electrical connections cannot be accessible to the user without the use of a tool.
- Low voltage or improper wiring may cause damage to this appliance. Read and follow all wiring instructions when connecting to power supply.

\*Information is subject to change without notice.

# SpaNet™ Controller Warnings

## SV Mini 1, SV Mini 2, SV2, SV3 & SV4

---

- Any damaged cable must be replaced immediately.
- To prevent electric shock hazard and/or water damage to this appliance, all unused receptacles must have a water proof seal in place.
- Parts incorporating electrical components must be located or fixed so that they cannot fall into the bath or spa.
- Parts containing live parts, except parts supplied with safety extra-low voltage not exceeding 12V must be inaccessible to a person in the bath or spa.
- This appliance must not be installed in proximity to highly flammable materials.
- Water temperature in excess of 38°C may cause hyperthermia (heat stress).
- It is the spa manufacturer's and/or installer's responsibility to select suitable loads and configure load shed settings (if required) to ensure the system does not exceed its rated maximum total load.
- It is the installer's responsibility to ensure the floor is capable of supporting the expected load of the bath or spa and an adequate drainage system has to be provided to deal with overflow water.
- A spa pool should incorporate a water filtration system where the required level of water purity can be achieved.
- An adequate drainage system has to be provided if the equipment is to be installed in a pit.

# SpaNet™ Controller Warnings

## SV Mini 1, SV Mini 2, SV2, SV3 & SV4

---

- This appliance is not intended for use by persons (including children) with reduced physical, sensory or mental capabilities, or lack of experience and knowledge, unless they have been given supervision or instruction concerning use of the appliance by a person responsible for their safety.
- Children should be supervised to ensure that they do not play with the appliance.



### SET THE DATE AND TIME BEFORE USING THE SPA

Be sure to set the date and time before operating the spa (refer to page 56 for SV Mini models and page 93 for SV2,SV3 & SV4 models).

Vital control functions require the time and date to be set correctly.

### POOR WATER MAINTENANCE CAN VOID YOUR WARRANTY

It is your responsibility to regularly check and maintain the chemical water balance of the spa pool to ensure it remains within reasonable levels as detailed in page 41). Unbalanced water chemistry greatly accelerates corrosion and may lead to early product or component failure. **Product or component failures caused as a result of poor water chemistry maintenance will NOT be covered by the Product Warranty.**

\*Information is subject to change without notice.

# Turn On Power

## SV Mini 1, SV Mini 2, SV2, SV3 & SV4

---

Turn on power to spa at the home's circuit breaker and isolation switch. The heater and filter/circulation pump will automatically activate.

- The spa will prime and this can take a few minutes. Priming is the process of water flowing through the circulation pump into the plumbing and back into the spa. If the priming is successful, you will see bubbles floating up from the foot-well.

**In the rare event that you see error 3 on the keypad during or after the priming has been activated:**

- Disconnect the power to the spa.
- Remove the cabinet to expose the circulation pump.  
**NOTE:** *There is only one pump on the SOUL100™*
- Turn the barrel union on the top of the small circulation pump slightly until air hisses out and then only water comes out.
- Tighten the barrel union back up.
- Apply power to the spa.
- If you continue to get an Er-3, remove the filter where you inserted the hose to fill the spa and make sure the isolation valves are open (see page 39 for more info.).
- If you still get an Er-3, contact your dealer.

**If you see error 4 on the keypad**

- Follow the same procedure for an Er- 3 but also loosen the heater barrel union until water comes out to remove any air.
- Apply power to the spa.
- If you continue to see an error 4, Er-4 on the control panels, contact your dealer.

# Electrical Installation

## SpaNet™ SV Mini 1™, SV Mini 2™, SV2, SV3 & SV4

### WARNING

- This appliance must be supplied through a residual current device (RCD) having a rated residual operating current not exceeding 30mA.
- Correct wiring of the main electricity board, RCD and spa pack is critical.
- When installing the appliance, refer to your local wiring regulations.
- It is recommended that when installing the mains power cable that a service loop (additional wire length for future serviceability) is provided.
- All electrical work must be performed by a licensed electrician in compliance with the local electrical regulations.

### IMPORTANT:

- All electrical connections must be performed by a licensed electrician and must conform to all national, state and local electrical codes in effect at the time of installation.
- The appliance should be supplied through a residual current device (RCD) having a rated residual operating current not exceeding 30mA.
- The supply line should be a dedicated power circuit. The installer should consider the sum total load of all devices connected to the SV Mini controller when determining the size of the power circuit and install an appropriately sized circuit breaker to suit. Ensure circuit breaker is rated for motor start up currents. Maximum rated power circuit is 25A.
- Heater load shedding is set by default, so that the heater load sheds and turns off as soon as any device other than Pump 1 is switched on. The installer should consider this when determining the size of the power circuit required. Heater load shedding can be adjusted if desired.

### Electrical specifications

Model	Max Current	Input Voltage	Phases	Hz	Heater Size
Mini 1 / Mini 2	25A	230-240V AC	1	50/60	1.5kW / 2.0 kW / 3.0kW

\*Information is subject to change without notice.

# Electrical Installation

## SpaNet™ SV Mini 1 Wiring

### Wiring diagram

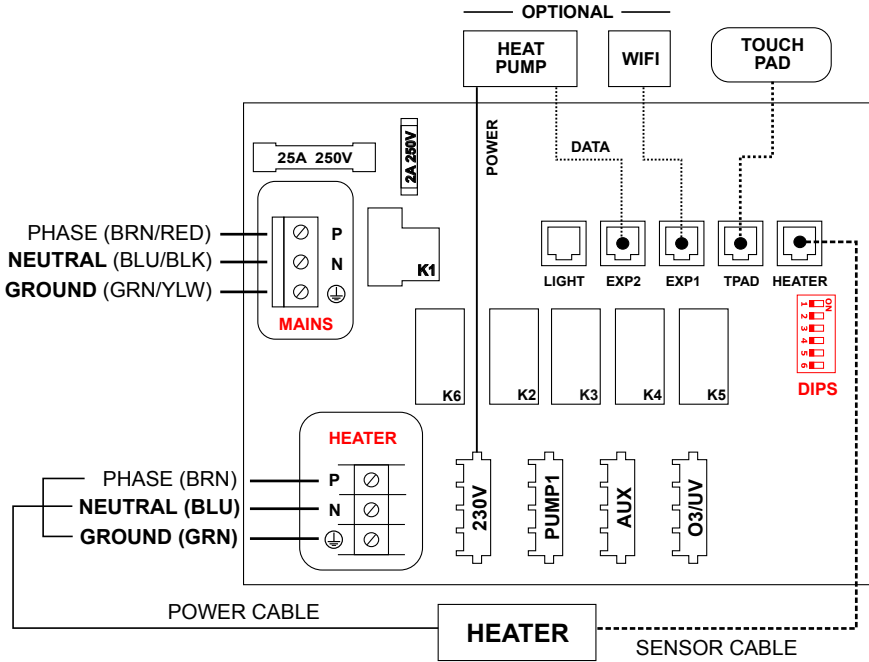

### SV Mini 1 output ratings

Model	Outlet	Max Current	Output Voltage	Hz	Heater Size
SV Mini 1	230V	10A	230-240V AC	50/60	1.5kW / 2.0 kW / 3.0kW
	Pump 1	10A	230-240V AC	50/60	Circ / 2-spd or 1-spd Pump
	Aux	10A	230-240V AC	50/60	1-spd Pump / Air Blower
	O3/UV	2A	230-240V AC	50/60	Ozone / UV Sanitiser

\*Information is subject to change without notice.

# Electrical Installation

## SpaNet™ SV Mini 2

### Wiring diagram

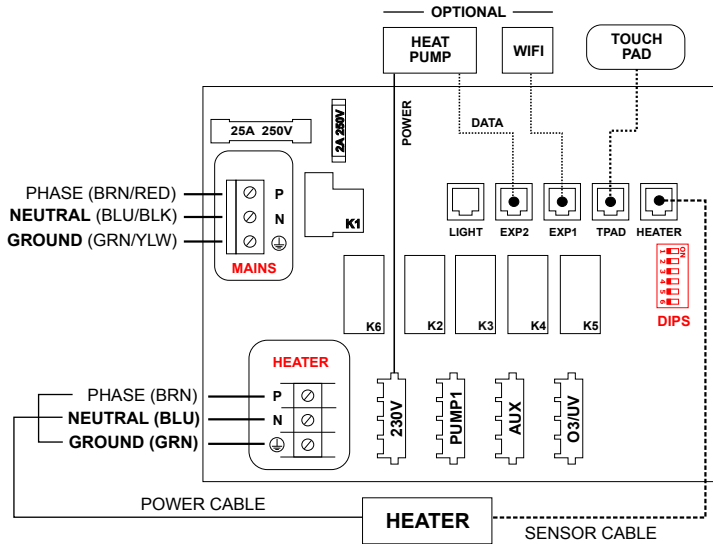

### SV Mini 2 output ratings

Model	Outlet	Max Current	Output Voltage	Hz	Heater Size
SV Mini 2	230V	10A	230-240V AC	50/60	1.5kW / 2.0 kW / 3.0kW
	Pump 1	10A	230-240V AC	50/60	Circ / 2-spd or 1-spd Pump
	Pump 2	10A	230-240V AC	50/60	1-spd Pump / Air Blower
	03/UV	2A	230-240V AC	50/60	Ozone / UV Sanitiser
	Pump 3	10A	230-240V AC	50/60	1-spd Pump
	Blower	4.5A	230-240V AC	50/60	Air Blower

\*Information is subject to change without notice.



# DIP Switches

## SpaNet™ SV Mini 1 & SV Mini2

The dip switches determine the configuration of pumps connected to the SV Mini controllers. The installer must correctly configure the dip switches to match the pump(s) connected to the spa controller. The dip switch bank (illustrated below) has six individual switches. Switches set to the right of the switch bank (away from the numbers) are in the ON position. Switches set to the left of the switch bank (closest to the numbers) are in the OFF position. Refer to diagram below for dip switch settings:



SW	Setting	OFF (left)	On (right)	Notes
1	Not used	-	-	-
2	Pump 1 Type	Single Speed	Two Speed	Determines if P1 = 1spd/2spd
3	Pump 3 Fitted *	Not Fitted	Fitted	Determines if P3 is connected
4	Not used	-	-	
5	Not used	-	-	
6	Not used	-	-	

\* SpaNet™ SV Mini 2 models only

**Note:** The dip switches will already be set by your spa manufacturer during production and should not require adjusting. This information is for reference when installing a new control to an existing spa.

# Electrical Installation

## SpaNet™ SV2,SV3 & SV4 Wiring

### 230-240V (3 wire) single phase

Terminal	Wiring
P3	Link to CS
P2	Link to CS
CS	Link to P3 and P2
P1	Phase
G	Earth
N	Neutral
Dip Switch 5	OFF
Dip Switch 6	OFF

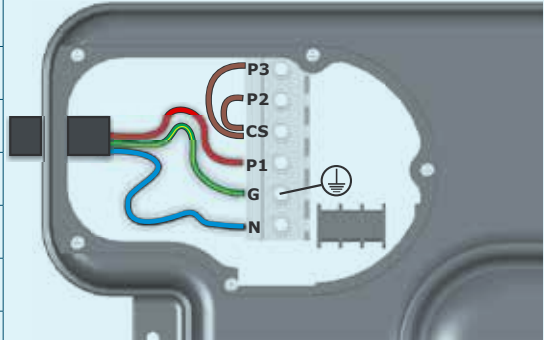

### 230-240V (4 wire) dual phase

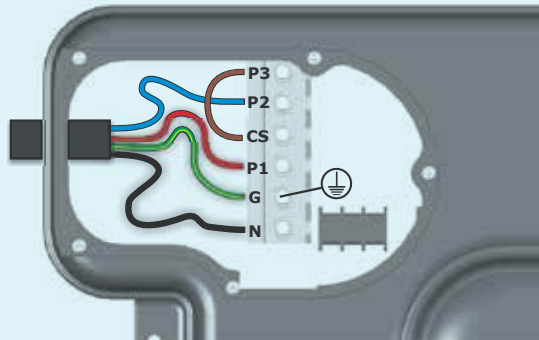

Terminal	Wiring
P3	Link to CS
P2	Phase 2
CS	Link to P3
P1	Phase 1
G	Earth
N	Neutral
Dip Switch 5	ON
Dip Switch 6	OFF

\*Information is subject to change without notice.

# Electrical Installation

## SpaNet™ SV2, SV3 & SV4 Wiring

### 230-240V (5 wire) three phase

Terminal	Wiring
P3	Phase 3
P2	Phase 2
CS	Not Used
P1	Phase 1
G	Earth
N	Neutral
Dip Switch 5	ON
Dip Switch 6	ON

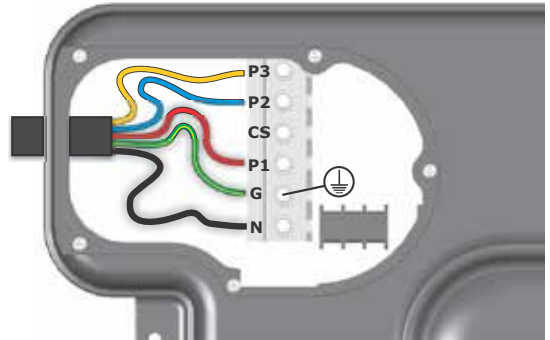

# DIP Switches

## SpaNet™ SV2, SV3 & SV4

### System configuration.

Basic spa configuration is achieved by setting dip switches. The dip switches determine pump configuration and select the number of input phases wired to the spa pack. The installer must correctly configure the dip switches to match the pump and power configuration connected to the spa pack.

The dip switch bank (pictured right) has six individual switches. Switches set to the top of the switch bank are in the ON position. Switches set to the bottom of the switch bank (closest to the numbers) are in the OFF position. Refer to tables below for dip switch settings:

SW	Setting	OFF	ON	NOTES SV2/SV4 Models
1	Circ Fitted	Not Fitted	Fitted	
2	Pump 1 Type	Single Speed	Two Speed	If set to 'OFF' pump2 assumed fitted
3	Pump 3 Type	Single Speed	Two Speed	Not used on SV2/SV2-VH models
4	Pump 4 Fitted	Not Fitted	Fitted	Not used on SV2/SV2-VH models
5	Phase Selection	Single Phase	2/3 Phase	If set to 'ON' dip switch 6 is enabled
6	Multi Phase	Two Phase	Three Phase	

SW	Setting	OFF	ON	NOTES SV3 Models
1	Circ Fitted	Not Fitted	Fitted	
2	Pump 1 Type	Single Speed	Two Speed	If set to 'OFF' pump2 assumed fitted
3	Pump 3 Fitted	Not Fitted	Fitted	
4	Not Used	-	-	
5	Phase Selection	Single Phase	2/3 Phase	If set to 'ON' dip switch 6 is enabled
6	Multi Phase	Two Phase	Three Phase	

\*Information is subject to change without notice.

# DIP Switches

## SpaNet™ SV2, SV3 & SV4

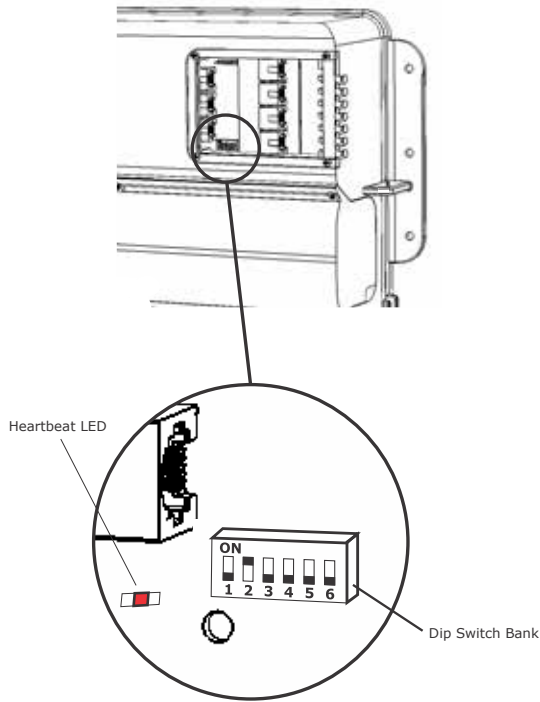

### Heartbeat LED

All SV model spa packs feature a heartbeat LED. The heartbeat LED flashes to indicate the current health/status of the spa pack. When the spa pack is functioning correctly with no errors to report the heartbeat LED emits a single flash in a constant pulse much like a heartbeat (ON, OFF, ON, OFF).

If the spa pack encounters a fault the heartbeat LED will begin flashing in sequence with the error code number being experienced (ie. ER2 = ON,ON; OFF ON,ON; OFF).



The heartbeat LED is located beside the bottom left hand corner of the dip switch bank and will emit its red flash through the tinted low voltage connection cover, making it clearly visible from the front of the spa pack.

# SpaNet™ SV Mini 1 & Mini 2



## Top Side Panel Layout

### SpaNet™ SV Mini 1





#### DISPLAY MODE ICONS

-  Water Temperature
-  Set Temperature
-  Clock

#### MENU ICONS

-  Sleep timer menu icon
-  Light menu icon
-  Blower menu icon

#### STATUS ICONS

-  Keypad locked
-  Sanitise cycle operating
-  Filtration cycle operating
-  Fault condition has occurred



- 1. UP button
- 2. DOWN button
- 3. OK button
- 4. Light On / Off
- 5. Pump A
- 6. Auxiliary
- 7. Auto Mode LED
- 8. Heater on LED
- 9. Sleep Cycle LED

\*Information is subject to change without notice.

# SpaNet™ SV Mini 2

## Topside Panel Layout



- |                   |                     |
|-------------------|---------------------|
| 1. UP button      | 7. Pump C           |
| 2. DOWN button    | 8. Air Blower       |
| 3. OK button      | 9. Sleep Cycle LED  |
| 4. Light On / Off | 10. Heater on LED   |
| 5. Pump A         | 11. Sleep Cycle LED |
| 6. Pump B         |                     |

\*Information is subject to change without notice.

# Topside Panels

## SpaNet™ SV Mini 1 & SV Mini 2

---

### LED Indicator lights

The topside panel function buttons (i.e. Pumps, Light, and Blower) feature a green LED light to clearly indicate whether the accessory is ON or OFF. The green LED will light up when the accessory is ON. In addition, the topside panels have three red indicator LEDs to advise the user the current status of the spa:

#### **AUTO** Automatic mode

The AUTO LED indicator turns ON when the filtration pump is in automatic mode. In automatic mode the filtration pump will turn on / off as required to satisfy heating and filtration requirements. If the filtration pump is manually turned on or off the AUTO LED indicator turns OFF. The control will automatically return to AUTO mode after a 45 minute idle timeout period if not returned to AUTO mode by the spa user.



#### **Heater ON**

The Heater LED indicator turns ON when the heater element is active. The heater is automatically controlled, it will turn ON and OFF as required (in conjunction with the filtration pump) to maintain the set water temperature. If the filtration pump is manually turned OFF the heater will NOT operate.

**NOTE:** *In some configurations, engaging high speed on a 2 speed pump or operating multiple pumps will cause the heater to load shed and turn OFF (even if heating is required) to keep the system within its rated power supply.*

#### **zZz** Sleep cycle ON



The Sleep Cycle LED indicator turns ON when the spa control is within a designated sleep cycle (if set). During a sleep cycle, all automatic system operation will stop so that the spa is silent – i.e. filtration and heating will not occur.



\*Information is subject to change without notice.



# Display Modes

## SpaNet™ SV Mini 1 & SV Mini 2

The SV Mini has three (3) x display modes. The spa user can scroll through the different displays by pressing a short single press of either the UP  or DOWN  button. Each display has a unique icon to indicate the current mode being viewed. As you scroll through each mode a brief title screen will be shown followed by the actual display mode (note change in icon). The available display modes are as follows:

Icon	Title	Display	Notes
	W.TMP	Water Temperature	1. The default display mode is (W.TMP) water temperature.
	S.TMP	Set Temperature	2. There is a 10 second inactivity timeout on all non-default displays. No button press for 10 secs display reverts to default.
	TIME	Clock	3. If no icon is displayed the temp shown is from when the filter pump last ran. Once the filter pump next runs for 10 mins the temp will update and W.TMP icon will return.

### OTHER DISPLAY ICONS



#### Filtration Cycle

The spa is carrying out filtration



#### Sanitise Cycle

The spa is carrying out a sanitisation cycle



#### Keypad Locked

The keypad has been locked



#### System Error

A fault has been detected. The system has halted operation so that corrective action can be taken. Take note of scrolling error code and consult trouble shooting section of this manual.

# Setting Date/Time

## SpaNet™ SV Mini 1 & SV Mini 2

---

Be sure to set the date and time before operating the spa. Vital functions such as filtration, sanitisation cycles and sleep timer settings depend on the time and date being set correctly.

- Press a short single press of the DOWN button to change display to Time/Clock setting
- Press the OK button to enter date/time adjustment
- The settings appear in the following order:
  - o Time Format (24 hr / 12 hr)
  - o Year (yyyy)
  - o Month (mm)
  - o Day (dd)
  - o Weekday (mon-sun)
  - o Hours (xx:00)
  - o Minutes (00:xx)
- Press the UP or DOWN buttons to adjust each setting
- Press the OK button to confirm each setting and skip to the next one
- Once the minutes have been selected and confirmed the system will exit the date/time adjustment and the display will return to the default display mode

**NOTES:** 1. Leap years are taken into account.

2. The system does not automatically adjust for daylight savings times. User must adjust manually.

3. The date/time clock has a capacitor backup which will hold the date/time even if mains power is turned off. The capacitor backup will last 8-12 hours. If power remains off for longer than this period the date/time may need to be set again.

\*Information is subject to change without notice.

# Automatic Heating/Filtration

## SpaNet™ SV Mini 1 & SV Mini 2

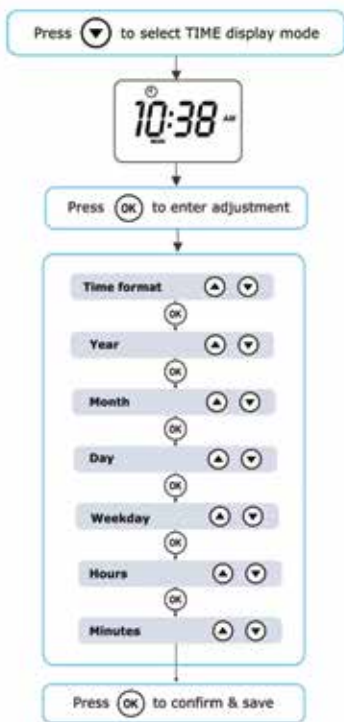

## Automatic heating/filtration

The SV Mini spa controls have been designed with simplicity in mind. Their intelligent software constantly monitors the spa water, automatically controlling the heater and filtration pump to ensure the desired set water temperature is maintained and required level of daily filtration achieved.

With set-and-forget technology, the spa user simply selects their desired water temperature (10°C - 41°C. Default = 38°C) and thereafter the spa control will automatically heat to and maintain that selected water temperature. This is called demand heating - the filtration pump and heater will be activated when required to maintain the set water temperature.

# Adjusting Set Temperature

## SpaNet™ SV Mini 1 & SV Mini 2

The time spent heating the pool and running the filtration pump under normal operation will be taken into account and where required the pump will run for additional periods every three hours to maintain the minimum level of daily filtration as set by the user.

Dependant on the amount of normal spa use, set water temperature, minimum hours of filtration per day, climatic conditions and season being experienced, the spa control will engage the heater and / or filtration pump for differing periods of time, at differing times of day. The advanced software constantly monitors and recalculates after each heating / filtration cycle to ensure the correct daily filtration time is achieved and desired set water temperature is maintained.

Unless adjusted the SV controller will automatically heat to and maintain the default temperature of 38°C. The water temperature set point can be adjusted from 10°C to 41°C in steps of 0.2°C increments.

### Adjusting set temperature

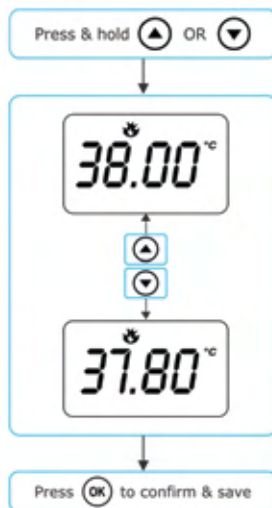

\*Information is subject to change without notice.

# Adjusting Set Temperature

## SpaNet™ SV Mini 1 & SV Mini 2

- Press and hold the UP or DOWN button to begin set temperature adjustment
- The display will show the (S.TMP) set temperature indicator icon, the main digits flash and temperature will begin adjusting
- Press the UP or DOWN buttons to adjust the set temperature by 0.2°C increments to your desired temperature
- Press OK to confirm and save setting, or wait for the 10 second idle timeout. The main digits will stop flashing and display returns to default display mode

- NOTES:**
- 1. During a heating cycle the SV Mini may raise the water temperature up to 0.5°C above set temperature point to provide an average water temperature of set point at most times.*
  - 2. If an optional heat pump is NOT fitted the spa controller has NO ability to cool the spa water. Lowering the set temperature point will NOT cause the water to cool.*
  - 3. If an optional heat pump IS fitted the spa water CAN be cooled as well as heated. Lowering the set temperature point will ensure the heat pump engages/disengages a cooling cycle (if required) to maintain the desired set water temperature so long as H.PMP mode is set to AUTO.*
  - 4. If the spa control has been in standby mode (idle) for some time and the set temperature point is adjusted, the filtration/circulation pump may run for up to ten (10) minutes to complete a mixing cycle before the heater / heat pump engages to heat or cool (heat pump only) the water. To skip this mixing cycle and begin heating/(cooling) immediately press the PUMP A button multiple times to toggle the filtration pump through ON/OFF/AUTO. Once AUTO is re-engaged the heater will activate immediately.*

# Pump Operation

## SpaNet™ SV Mini 1

A designated filtration pump (pump 1) will automatically switch on and off as required to perform filtration and heating functions. All pump(s) will also operate for a short period during the daily sanitise cycle. In addition, the following manual pump controls are provided and will override automatic control.

The pump buttons are located on the right-hand side of the topside panels. The functions of the pump buttons change depending on pump configuration, however the Pump-A button is used to control the filtration pump (pump 1). For every press of a pump button the screen will temporarily display the selected pump state: ON, OFF, LOW, HIGH or AUTO and then revert to the default display mode. Possible pump configurations & button sequences are referenced in the tables below:

### SpaNet™ SV Mini 1 pump buttons

SPA CONFIGURATION	PUMP A BUTTON	AUXILIARY BUTTON
<b>Pump 1 = 2 speed</b> Aux = Not Fitted	<b>2 speed pump:</b> Low / High / Off / Auto	-
<b>Pump 1 = 1 speed</b> Aux = Not Fitted	<b>1 speed pump:</b> On / Off / Auto	-
<b>Pump 1 = 2 speed</b> Aux = 1 speed or Blower	<b>2 speed pump:</b> Low / High / Off / Auto	<b>1 speed pump or Blower:</b> On / Off
<b>Pump 1 = Circ or 1 speed</b> Aux = 1 speed or Blower	<b>Circ pump or 1 speed pump:</b> On / Off / Auto	<b>1 speed pump or Blower:</b> On / Off

\*Information is subject to change without notice.

# Pump Operation

## SpaNet™ SV Mini 2

### SpaNet™ SV Mini 2 pump buttons

SPA CONFIGURATION	PUMP A	PUMP B	PUMP C	AUXILIARY BUTTON
Pump 1 = 2 speed Pump 2 = 1 speed Pump 3 = Not Fitted Blower = Fitted	2 speed pump: Low / High / Off / Auto	1 speed: On / Off	-	Vari / Ramp /Off
Pump 1 = Circ or 1 spd Pump 2 = 1 speed Pump 3 = Not Fitted Blower = Fitted	Circ pump or 1 spd: On / Off / Auto	1 speed: On / Off	-	Vari / Ramp /Off
Pump 1 = Circ Pump 2 = 1 speed Pump 3 = 1 speed Blower = Not Fitted	Circ pump: On / Off / Auto	1 speed: On / Off	1 speed: On / Off	-
Pump 1 = Circ Pump 2 = 1 speed Pump 3 = 1 speed Blower = Not Fitted	Circ pump: On / Off / Auto	1 speed: On / Off	1 speed: On / Off	Vari / Ramp /Off

- NOTES:**
- If left ON, pumps automatically turn OFF after a 30 minute time-out period from the last button press.*
  - If pump 1 is operating and heater is ON and pump is to be switched OFF, the pump will turn off after a 5 second delay – to allow the heater to cool down.*
  - In some configurations, engaging high speed on a 2 speed pump or operating multiple pumps will cause the heater to load shed and turn OFF (even if heating is required) to keep the system within its available power supply.*

# Blower Operation

## SpaNet™ SV Mini 2

### Blower operation SV Mini 2 models only

SV Mini 2 models feature a dedicated air blower power socket and button. The blower button is used to toggle the air blower ON/OFF and allow adjustment of the blower speed. The selected speed is saved and will be restored the next time the blower is turned on, for future on/off use. Two modes of operation are provided.

#### Variable speed mode

- Press the BLOWER button once to activate blower in variable speed mode
- Display will flash VARI then present the blower speed (b.SPД) adjustment menu
- Press the UP or DOWN buttons to increase/decrease blower speed
- Press the OK button to confirm or wait for 10 second idle time-out
- Once running press the BLOWER button again to turn blower OFF

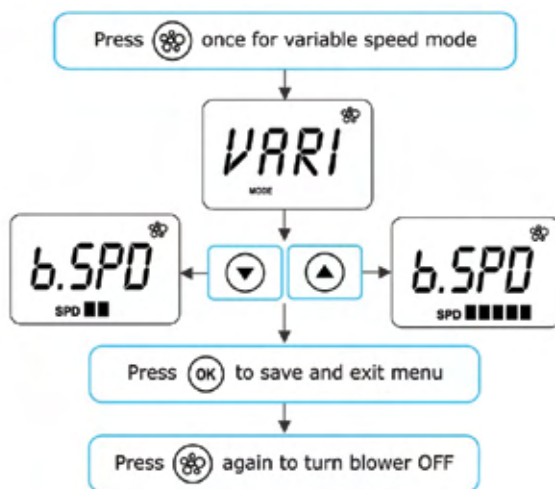

\*Information is subject to change without notice.



# Blower Operation

## SpaNet™ SV Mini 2

### Ramping mode

- Press the BLOWER button TWICE to activate blower in ramping mode
- Display will flash RAMP and blower operates in a ramping speed manner
- Once running press the BLOWER button again to turn blower OFF

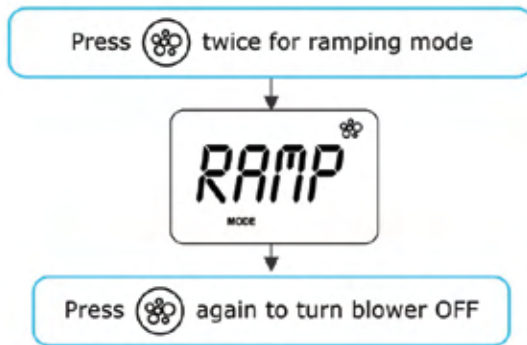

- NOTES:**
1. When blower is first turned ON it will always run at maximum speed for 3-4 seconds before changing to the last used speed.
  2. If left ON, blower will automatically turn OFF after a 30 minute time-out period from the last button press.

# Light Operation



## SpaNet™ SV Mini 1 & SV Mini 2

### Multi-colour LED lighting effects

The light button is used to toggle the spa light(s) ON / OFF and to access the light mode menus. The features that can be adjusted are the light colour, light effect mode, light effect transition speed, and light brightness. All light settings are saved and will be restored the next time the light is turned ON, for future ON / OFF use.

### Selecting light colour or effect mode

Press the LIGHT  button to turn light(s) on/off => light will display last used light mode. If no changes are required there is no need to do anything further. If however you wish to adjust the light settings refer below:

Use the UP  or DOWN  buttons to toggle between the two light modes:

Title	Mode	Description	
U.CLR	User Colour	Select from 7 possible colours	
FADE	Fade Effect	Fade transition through all colours	

\*Information is subject to change without notice.

# Light Operation

## SpaNet™ SV Mini 1 & SV Mini 2

### User colour mode

If user colour mode is selected press OK or wait 10 seconds for the display to show the current selected colour number. There are 7 colours to choose from (CL:00 – CL:07). Use the UP or DOWN buttons to adjust the colour. Press OK to confirm and skip to the light brightness adjustment or wait for the 10 second inactivity time out.



### Fade effect mode

If fade effect mode is selected press OK or wait 10 seconds for the display to show the light speed (L.SPД) adjustment screen where the speed of the fade transition between colours can be adjusted. Use the UP or DOWN buttons to increase or decrease the transition speed to your desired level. Press OK to confirm and skip to the light brightness adjustment or wait for the 10 second inactivity time out inactivity time out.



### Light brightness

Once light mode and colour or light speed has been selected the controller offers a light brightness adjustment. Use the UP or DOWN buttons to increase/decrease the light brightness to your desired level. Press OK to confirm or wait for the 10 second inactivity timeout.



# Keylock Function

## SpaNet™ SV Mini 1 & SV Mini 2

- NOTES:**
- 1. The light mode / user colour / light speed / light brightness adjustment screens are only displayed for 10 seconds each when the light(s) are first turned ON. If no adjustment is made the light(s) will run as per the last used settings, and the screen will time-out and revert to the default display mode. If you wish to adjust the light(s) settings once the light(s) have been running for a period of time, the light(s) must be turned OFF and back ON again to restore the light mode adjustment screens.*
  - 2. If left ON, the light(s) will automatically turn OFF after a 45 minute time out period from the last button press.*

## Keylock function

### How to set full or partial keylock

The keypad buttons can be locked to prevent accidental key presses or to limit access to certain controller functions. This feature is helpful where children are present or spa is used by many people.

There are two types of keylock:

**Full Lock**                      All buttons are disabled

**Partial Lock**                      Allows use of pumps, blower, and light but locks out settings and temperature adjustments

### Full Lock

- Press and hold UP + DOWN + PUMP A until LOCK appears on the display
- Once locked if any button is pressed the key stroke will be ignored and display will show LOCK



\*Information is subject to change without notice.

# Auto Daily Sanitise

## SpaNet™ SV Mini 1 & SV Mini 2

- To unlock press and hold UP + DOWN + PUMP A

### Partial Lock

- Press and hold UP + DOWN + PUMP B until LOCK appears on the display
- Once locked only pumps, blower, and light can be used. Other key strokes will be ignored and display will show LOCK
- To unlock press and hold UP + DOWN + PUMP B



### AUTO daily sanitise

The controller will automatically run a 10 minute sanitise cycle every day at 9:00am. This sanitisation cycle runs the filtration pump and ozone/UV (if fitted) to filter the pool water to restore and refresh water quality. If pump 1 is a 2 speed pump the pump will run in high speed for the duration of the cycle. In addition at the start and end of the cycle the controller will sequentially run any additional accessories (auxiliary, pump2, pump3 or blower if fitted) for one minute each to purge the plumbing and clear any unfiltered water trapped in those accessory lines.

- NOTES:**
1. *If the controller is in a programmed sleep period at 9:00am it will wait until the sleep period ends before the daily sanitise cycle runs.*
  2. *If the spa is in use prior to the 9:00am sanitise cycle start time the cycle is cancelled for the day. Spa in use = button has been pressed and spa has not had the 45 minute inactivity time out expire since the last button press.*

# Set-up Menu

## SpaNet™ SV Mini 1 & SV Mini 2

### Set-up menu

The SV Mini controllers feature a setup menu which allows customisation of adjustable software settings. These settings do not need to be modified often and in most cases the default settings are all that is required, however if the spa owner wishes to customise any settings it is completed through the setup menu.

- To access the setup menu press and hold the UP + DOWN buttons simultaneously until display shows FILT
- Use the UP or DOWN buttons to navigate through setup menu items
- Press the OK button to enter setting adjustments
- Press the UP or DOWN buttons to adjust setting
- Press the OK button to confirm and save the setting adjustment



Refer table on the following page for details on setup menu items.

- NOTES:**
- 1. The setup menu settings are stored in non-volatile memory (EEPROM) and are remembered when the mains power is turned OFF. No need to reprogram settings when power is restored.*
  - 2. A ten (10) second idle menu time out period exists. If a button press is not detected for 10 seconds the menu will time out and the screen will return to the default display mode.*

\*Information is subject to change without notice.

# Set-up Menu

## SpaNet™ SV Mini 1 & SV Mini 2

Item	Settings	Notes
FILT	Hours of filtration per day	Adjustable from 1 to 24 hours
SNZE	Sleep Timer Menu	
1.SNZ	Sleep timer 1	[1.DAY] Days of week, [1.BGN] Begin Time, [1.END] End Time
D.DIS	Default display mode	Water Temp (W.TMP) / Set Temp (S.TMP) / Clock (TIME)
WIFI	WiFi Setup Menu	
HOT	Hot spot mode	Activates hot spot mode for WiFi setup process
INFR	Infrastructure mode	Force a disconnect/reconnect to WiFi server to refresh connection
RSET	Reset WiFi module	Deletes all settings and prepares WiFi module for setup process
H.PMP*	Heat pump mode	Auto (heat & cool) / Heat only / Cool only / Off (HP disabled)
H.ELE*	HP + element boost	Off = heat pump only, electric heater disabled (default setting) On = heat pump + electric heater combined for heating

\* H.PMP and H.ELE setup menu items will only be visible if a SV Series heat pump is installed and connected to the SV Mini control.

# Set-up Menu

## SpaNet™ SV Mini 1 & SV Mini 2

### FILT – Filtration (total hours per day)

Automatic filtration is provided to ensure that the pool water is filtered for at least a minimum number of hours each day. Total daily runtime can be adjusted from 1-24 hours (default = 2 hours). Total filtration runtime is broken into smaller blocks which occur every three hours. All time spent running the pump under normal operation (manual use, heating, sanitise cycle) will be taken into account and where required the pump will run for additional periods throughout the day to maintain the minimum level of daily filtration as specified by the user.

### SNZE – Sleep Timer

The sleep timer is a very handy feature that enables the user to stop all spa activity and silence the spa during certain times of day or night. While the controller is sleeping NO automatic heating or filtration maintenance will occur, however the spa can still be operated by manual use without the need to adjust sleep time settings. The sleep timer setup consists of defining days of operation and begin time and end time of sleep period. Use the UP or DOWN button to adjust each setting within the sleep setup and press OK to confirm and skip to the next setting. Sleep timer settings are referenced in this table:

Title	Settings	Options
1.DAY	Selected days of operation	Sat-Fri (7 days), Sat-Sun (weekend), Mon-Fri (weekdays), OFF
1.BGN	Time sleep period begins	Adjustable to any time 0:00 to 23:59 (Default = 22:00 PM)
1.END	Time sleep period begins	Adjustable to any time 0:00 to 23:59 (Default = 07:00 AM)

\*Information is subject to change without notice.



# Set-up Menu

## SpaNet™ SV Mini 1 & SV Mini 2

- NOTES:**
- 1. SV Mini is preset with a default sleep timer – 7 days a week, begin 22:00 (10PM), end 07:00 (7AM)*
  - 2. Set 1.DAY=OFF to disable sleep timer*
  - 3. If spa in use at begin time of sleep period, spa will not sleep until 45 min inactivity timeout has elapsed*

### D.DIS – Default Display

The user can adjust the default display mode to show their preferred selection of either: W.TMP (water temperature), S.TMP (set temperature) or TIME (current time and day).

### WiFi – WiFi Setup

This menu is only of use if the optional SpaNET™ SmartLINK™ or SmartSTREAM™ WiFi module has been installed and connected to the SV Mini. This menu has three commands that can be executed. Use the UP or DOWN buttons to select desired command and press the OK button to execute – display will show WAIT whilst the WiFi module carries out the command.

- HOT** Puts WiFi module in hot spot mode for initial app setup. **Note:** Once initial app setup has been completed if the HOT command is executed again all WiFi settings Once locked if any button is pressed the key stroke will
- INFR** Forces WiFi module to disconnect/reconnect from the SpaNET™ app server to refresh connection if spa is not automatically coming online once the app setup process has been completed.
- RSET** Deletes programmed settings from WiFi module and returns the module to its factory default state. **Note:** If this command is executed settings are lost and the app setup process must be run again.

# Set-up Menu

## SpaNet™ SV Mini 1 & SV Mini 2

---

### H.PMP – Heat Pump Mode

This setting is only visible if a SV Series heat pump is connected and defines heat pump operating mode.

The available operating modes are as follows:

- AUTO Heat pump will heat and cool
- HEAT Heat pump will only heat (Default)
- COOL Heat pump will only cool
- OFF Heat pump disabled

### H.ELE – Heat Pump + SV Element Boost

This setting is only visible if a SV Series heat pump is connected and defines how the SV Mini electric heating element operates with a heat pump. By default, this setting is set to OFF which disables the electric heater using only the heat pump for heating. Set to ON to allow the electric element to run in conjunction with the heat pump to boost heating speed if the water temperature is 2°C or more below set temperature point or the heat pump has been operating for more than 1 hour and set point has not been achieved. The H.ELE setting choices are:

- OFF SV element disabled (heat pump only)
- ON SV element + Heat Pump for heating

\*Information is subject to change without notice.

# Heating Control & Protection

## SpaNet™ SV Mini 1 & SV Mini 2

---

### Fast heat cycle

After initial mains power on the SV Mini will perform a fast heat up cycle that enables continuous demand heating regardless of programmed/default sleep timer. Once the set temperature has been reached the fast heat up cycle is cancelled and normal operation resumes and sleep timer is obeyed. The purpose of a fast heat up cycle is to help the spa reach set temperature as soon as possible after it has been powered up. For new spas or spas refilled with cold water it is desirable not to have sleep time delaying the time to takes for the spa to reach set temperature point.

- NOTES:**
- 1. A fast heat up cycle is cancelled by manually forcing the filtration pump to OFF via the keypad.*
  - 2. For new spas or when a spa has just been refilled it is common for spa users to test the operation of each pump when the power is first turned on. This process will cancel the fast heat up cycle. After completing testing of the spa functions remember to reset mains power if you wish to reactivate fast heat up cycle.*

### Freeze protection

Freeze protection will be activated whenever the water temperature drops below 4°C. It runs back to back 10 minute sanitise cycles and displays “WARM” on the LCD. It also runs each spa accessory (i.e. jet pumps and air blower) in sequence to run water through the pipe work whilst running the filtration pump and heater. During the “WARM” cycle the heater and heat pump (if fitted) will operate however heater load shedding may occur when accessory pumps are running depending on control and load shed settings. At the end of each 10 minute “WARM” cycle the water temperature is checked. If it is above 4°C freeze protection stops and the controller returns to its prior state. If the temperature is not above 4°C another cycle will run.

# Heating Control & Protection

## SpaNet™ SV Mini 1 & SV Mini 2

**NOTES:** *Freeze protection overrides the sleep timer– if the water temperature drops below 4°C and the controller is in a sleep period it will wake up. So even if high amounts of sleep time and a low set temperature point have been programmed the SV Mini will always maintain the water temperature at least above 4°C.*

### Defrost cycle (heat pump models only)

During periods of low ambient temperatures defrost cycles may be required to prevent the heat pump's condenser from freezing. Ambient and condenser temperatures are constantly monitored and defrost cycles will be automatically activated if certain conditions are met. Defrost cycles run for a minimum of 3 minutes to a maximum of 10 min.

### Overheat protection

All SV controllers feature three forms of overheat protection:

1. If sensed water temperature within the heater unit exceeds safe working limits the heating element will be disabled and the controller will shut down and latch fault code (ER4 - Thermal Trip). Normal operation will not resume until heater element has cooled and main power is reset
2. If sensed water temperature exceeds 42°C filtration is stopped until the temperature falls below 42°C to prevent heat rise from filtration pump operation
3. If sensed water temperature exceeds 45°C the controller will shut down and latch fault code (Er5 - Pool too hot, see page 96). Normal operation will not resume until mains power is reset

\*Information is subject to change without notice.

# Error Codes/Troubleshooting

## SpaNet™ SV Mini 1 & SV Mini 2

---

SV spa controllers feature self-diagnostics and scrolling error messages to quickly troubleshoot possible problems. Should the spa control encounter a problem the error code / message will scroll across the topside panel screen until the problem is resolved. If an error condition is experienced all spa functions are shut down and the spa should not be used until the error condition has been resolved. A list of error codes with descriptions of problems and possible solutions is detailed below for your reference.

### IMPORTANT NOTE

- *For most error codes mains power to the spa control must be turned OFF and then back ON before the error condition will be cleared. Before attempting any troubleshooting always ensure mains power is isolated and turned OFF.*

### Heartbeat LED

All SV Mini spa packs feature a red flashing heartbeat LED light. The heartbeat LED is located on the main printed circuit board of the spa pack itself (spa pack enclosure cover needs to be removed).

The heartbeat LED flashes to indicate the current health/status of the spa pack. When the spa pack is functioning correctly with no errors to report the heartbeat LED emits a single flash in a constant pulse much like a heartbeat (ON, OFF, ON, OFF). If the spa pack encounters a fault the heartbeat LED will begin flashing in sequence with the error code number being experienced (ie. ER2 = ON,ON; OFF ON,ON; OFF).

If the keypad display is ever blank a spa user can still determine the health / status of the SV Mini controller by removing a panel from the spa skirt and checking the heartbeat LED on the front of the spa pack itself.

# Error Codes/Troubleshooting

## SpaNet™ SV Mini 1 & SV Mini 2

---

### ER-2 HEATER PLUG

**Problem:** No heater sensor communication

**Cause:** Heater sensor communication problem. Sensor cable is not correctly connected to spa control or is damaged

**Solutions:**

- Turn mains power OFF, remove spa cabinet panel and SV Mini enclosure cover
- Check heater sensor cable is firmly plugged into spa control socket labelled HEATER
- Unplug and re-plug heater sensor cable to re-establish connection to spa control
- Check for damage to sensor lead, replace covers and test spa again
- Contact spa reseller if problem is not resolved

### ER-3 WATER PRIME

**Problem:** Water prime failed – air detected in heater tube

**Cause:** Airlock in pipe work, low water level, dirty filter cartridges

**Solutions:**

- Press Pump A button to retry water prime
- Check spa water level (refill if necessary)
- Remove filter cartridges and press Pump A button to retry prime
- Bleed airlock from pipe work by slightly loosening couplings on front of filtration pump
- Remove filter cartridges and flush water down pipe work with a hose

\*Information is subject to change without notice.

# Error Codes/Troubleshooting

## SpaNet™ SV Mini 1 & SV Mini 2

---

### ER-4 THERMAL TRIP

**Problem:** Heater thermal trip activated. Heater has been active and has had insufficient water flow over the element. Low or no water flow has caused the heater temperature to exceed its maximum limits and the spa control has shut down operation to prevent any damage to the heater unit.

**Cause:** Low water level, airlock in pipe work, closed shut-off valves, dirty filter cartridges, filtration pump failed or operation intermittent

- Solutions:**
- Turn mains power OFF and wait 20-30 minutes for element to cool and thermal cut-out device to reset. Then turn power back ON
  - Check spa water level (refill if necessary)
  - Remove filter cartridges and clean as per manufacturer's recommendations or replace cartridges if required
  - Check under spa cabinet to ensure all shut-off valves are in the OPEN position
  - Bleed airlock from pipe work by slightly loosening couplings on front of filtration pump or by removing filters and flushing water down pipe work with a hose.
  - Contact your spa reseller if problem persists

# Error Codes/Troubleshooting

## SpaNet™ SV Mini 1 & SV Mini 2

---

### ER-5 POOL TOO HOT

**Problem:** Pool over temperature. Temperature sensor reading  $\geq 45^{\circ}\text{C}$ .

**Cause:** High ambient temperatures (especially in summer months) have caused water temperature to rise above set temp point, Excessive filtration time, Jet pumps have been operating for extended periods with the spa cover still on.

- Solutions:**
- Turn mains power OFF, remove spa cover, allow spa to cool then turn power back ON
  - Check daily filtration time (refer filtration section) and reduce daily filtration time if required
  - Check spa cover is not resting on topside panel buttons causing jet pumps to start when cover is on. Use keylock function to lock keypad buttons when spa not in use
  - Contact your spa reseller if problem persists

### ER-6 12V OVERLOAD

**Problem:** 12V (port) current draw over 1A limit

**Cause:** Total 12V current drawn by keypad(s), light(s), expansion ports and in pool temp sensor is excessive, 12V power supply is overloaded, too many LED light bulbs installed, faulty LED light

- Solutions:**
- Turn mains power OFF and restart spa to see if problem reoccurs
  - Perform EPRM software reset to factory defaults
  - Reduce number of LED lights connected to spa control
  - Systematically unplug lights, keypads and expansion port loads from spa pack (one by one) to identify the faulty 12V device
  - Contact spa reseller if problem is not resolved

\*Information is subject to change without notice.



# Error Codes/Troubleshooting

## SpaNet™ SV Mini 1 & SV Mini 2

---

### ER-8 CTRL FAULT HVS

**Problem:** Heater relay is on when it should be off

**Cause:** Power surge, periods of low or high voltage, water on spa pack terminal block, relay fault

- Solutions:**
- Turn mains power OFF and back ON again to see if spa control recovers from ER8 fault
  - Inspect under spa cabinet for evidence of water leaking onto spa control. If water present, turn mains power OFF and isolate, then resolve leak, dry up excess water, and allow spa control to dry out before restoring power.
  - Contact spa reseller if problem is not resolved

# SpaNet™ SV2

## Topside Panel

### Keypad Overview

Buttons and indicator LEDs

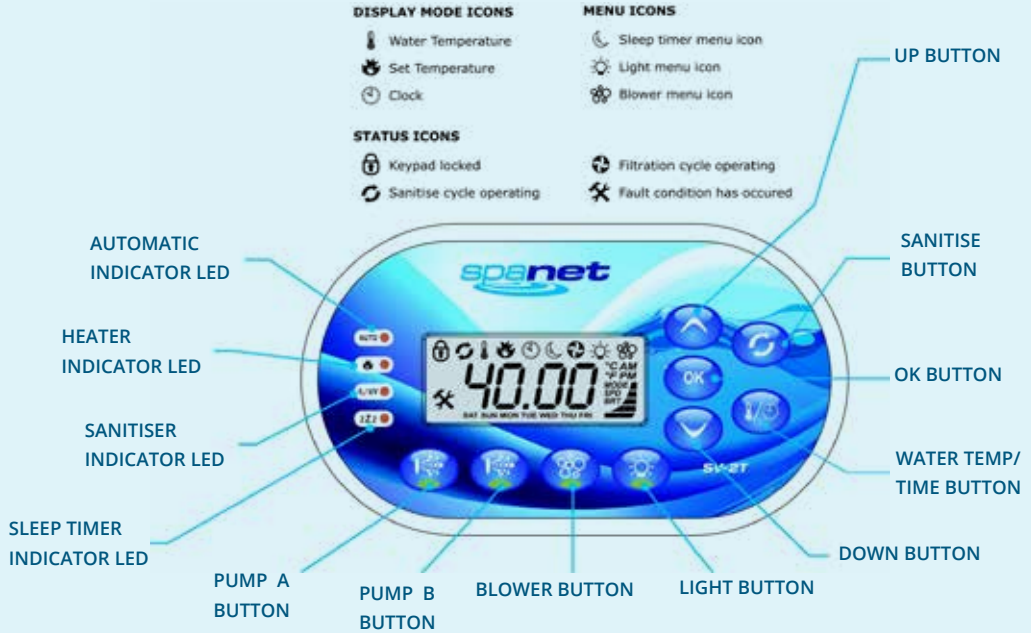

**AUTOMATIC INDICATOR LED:** This LED will turn on whenever the filtration pump is in automatic mode.

**HEATER INDICATOR LED:** This LED will turn on when the heater or heat pump (if fitted) is operating.

**SANITISER INDICATOR LED:** This LED will turn on to indicate that the ozone or uv sanitiser unit is operating (if fitted).

**SLEEP TIMER INDICATOR LED:** This LED will turn on when the controller is in a sleep mode.

**PUMP A BUTTON:** Used to toggle the filtration pump on / off / auto.

\*Information is subject to change without notice.

# SpaNet™ SV2

## Topside Panel

---

**PUMP B BUTTON:** Used to toggle any additional jet pump on / off (if fitted).

**BLOWER BUTTON:** Press to toggle blower on/off. A single press turns blower on in vari-speed mode. Use up & down buttons to vary speed. A double press activates the ramping mode.

**LIGHT BUTTON:** Press to toggle spa lights on / off. When light is first turned on the user has the ability to adjust the light effect mode or colour via the up, down & OK buttons.

**DOWN BUTTON:** Short single presses toggle through the three display modes:

W.TMP = Water Temperature, S.TMP = Set Temperature, TIME = Clock.

Holding the button will force the controller to begin adjusting the set temperature and will lower the set temperature point.

Also used for adjusting settings.

**WATER TEMP / TIME BUTTON:** A shortcut key designed to quickly toggle between actual water temp and time display modes.

**OK BUTTON:** Used to confirm and save setting adjustments or to enter setting adjustment menus.

**SANITISE BUTTON:** Press once to activate a 20 minute sanitisation and clean up cycle to refresh water quality after spa use. A second press will cancel the cycle if already running.

**UP BUTTON:** Short single presses toggle through the three display modes:

W.TMP = Water Temperature, S.TMP = Set Temperature, TIME = Clock.

Holding the button will force the controller to begin adjusting the set temperature and will raise the set temperature point.

Also used for adjusting settings.

# SpaNet™ SV3

## Topside Panel

### Keypad Overview

Buttons and indicator LEDs

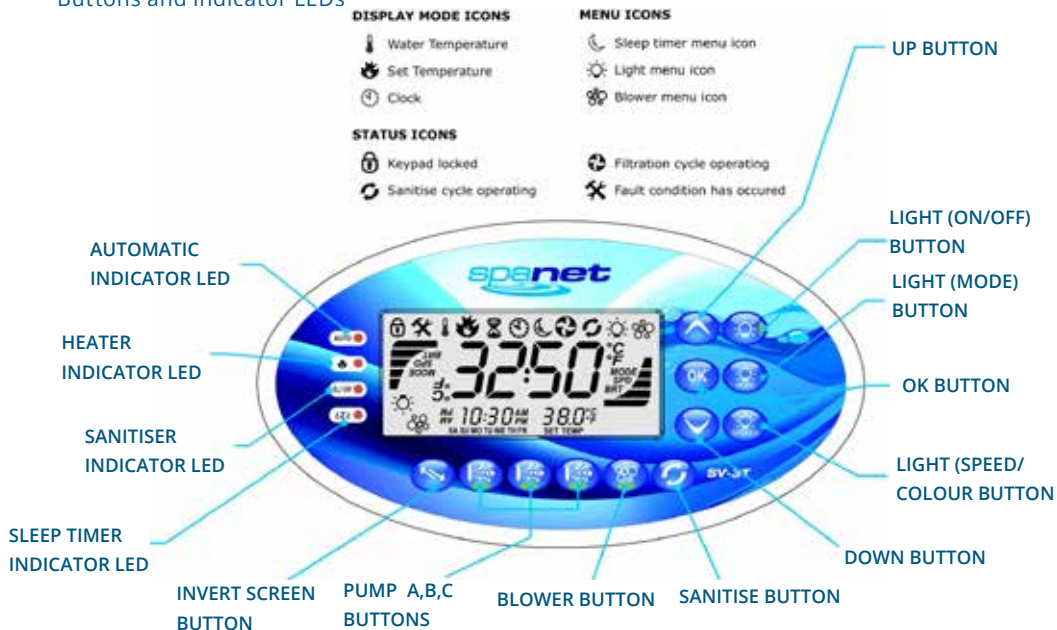

**AUTOMATIC INDICATOR LED:** This LED will turn on whenever the filtration pump is in automatic mode.

**HEATER INDICATOR LED:** This LED will turn on when the heater or heat pump (if fitted) is operating.

**SANITISER INDICATOR LED:** This LED will turn on to indicate that the ozone or uv sanitiser unit is operating (if fitted).

**SLEEP TIMER INDICATOR LED:** This LED will turn on when the controller is in a sleep mode.

**INVERT SCREEN BUTTON:** Press to flip screen 180° for easy viewing when spa in use..

\*Information is subject to change without notice.

# SpaNet™ SV3

## Topside Panel

---

**PUMP (A, B, C) BUTTON:** Used to toggle filtration pump and / or any additional jet pump(s) on / off (if fitted).

**BLOWER BUTTON:** Press to toggle blower on/off. A single press turns blower on in vari-speed mode. Use up & down buttons to vary speed. A double press activates the ramping mode.

**SANITISE BUTTON:** Press once to activate a 20 minute sanitisation and clean up cycle to refresh water quality after spa use. A second press will cancel the cycle if already running.

**DOWN BUTTON:** Short single presses toggle through the three display modes:

W.TMP = Water Temperature, S.TMP = Set Temperature, TIME = Clock.

Holding the button will force the controller to begin adjusting the set temperature and will lower the set temperature point.

Also used for adjusting settings.

**LIGHT (SPEED/COLOUR) BUTTON:** Press to activate light speed or user colour selection menus. Use up & down buttons to adjust.

**OK BUTTON:** Used to confirm and save setting adjustments or to enter setting adjustment menus.

**LIGHT (MODE) BUTTON:** Press to activate light mode menu & use up & down buttons to select one of five different lighting effect modes.

**LIGHT (ON/OFF) BUTTON:** Press to toggle spa lights on / off.

**UP BUTTON:** Short single presses toggle through the three display modes:

W.TMP = Water Temperature, S.TMP = Set Temperature, TIME = Clock.

Holding the button will force the controller to begin adjusting the set temperature and will raise the set temperature point. Also used for adjusting settings.

# SpaNet™ SV4

## Topside Panel

### Keypad Overview

#### Buttons and indicator LEDs

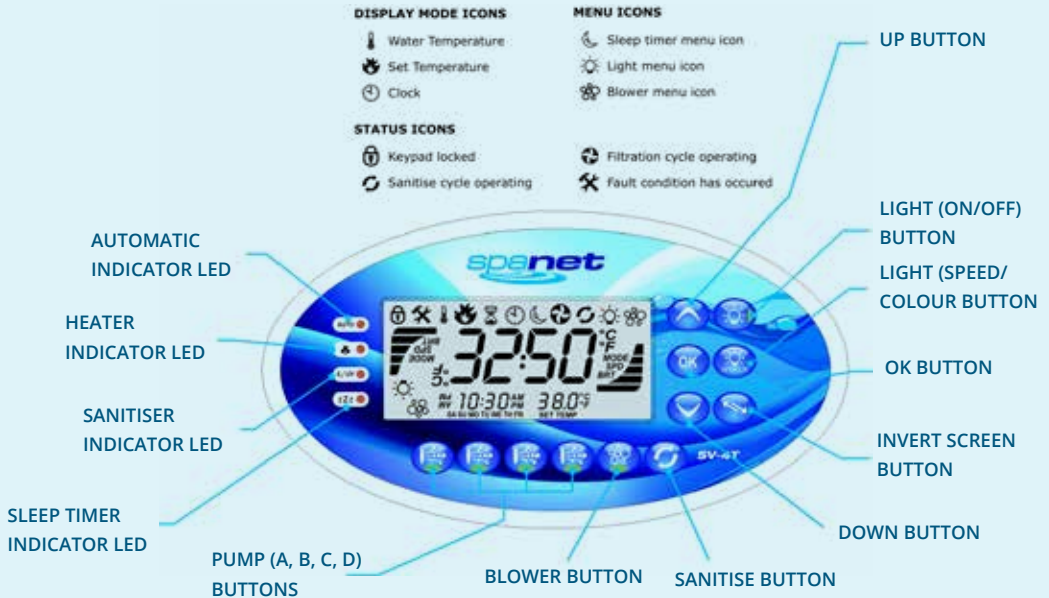

**AUTOMATIC INDICATOR LED:** This LED will turn on whenever the filtration pump is in automatic mode.

**HEATER INDICATOR LED:** This LED will turn on when the heater or heat pump (if fitted) is operating.

**SANITISER INDICATOR LED:** This LED will turn on to indicate that the ozone or uv sanitiser unit is operating (if fitted).

**SLEEP TIMER INDICATOR LED:** This LED will turn on when the controller is in a sleep mode.

\*Information is subject to change without notice.

# SpaNet™ SV4

## Topside Panel

---

**PUMP (A, B, C, D) BUTTON:** Used to toggle filtration pump and / or any additional jet pump(s) on / off (if fitted).

**BLOWER BUTTON:** Press to toggle blower on/off. A single press turns blower on in vari-speed mode. Use up & down buttons to vary speed. A double press activates the ramping mode.

**SANITISE BUTTON:** Press once to activate a 20 minute sanitisation and clean up cycle to refresh water quality after spa use. A second press will cancel the cycle if already running.

**DOWN BUTTON:** Short single presses toggle through the three display modes:

W.TMP = Water Temperature, S.TMP = Set Temperature, TIME = Clock.

Holding the button will force the controller to begin adjusting the set temperature and will lower the set temperature point.

Also used for adjusting settings.

**INVERT SCREEN BUTTON:** Press to flip screen 180° for easy viewing when spa in use.

**OK BUTTON:** Used to confirm and save setting adjustments or to enter setting adjustment menus.

**LIGHT (SPEED/COLOUR) BUTTON:** Press to activate light speed or user colour selection menus. Use up & down buttons to adjust.

**LIGHT (ON/OFF) BUTTON:** Press to toggle spa lights on / off.

**UP BUTTON:** Short single presses toggle through the three display modes:

W.TMP = Water Temperature, S.TMP = Set Temperature, TIME = Clock.

Holding the button will force the controller to begin adjusting the set temperature and will raise the set temperature point. Also used for adjusting settings. Purge air from plumbing system.

# SpaNet™ SV2, SV3 & SV4

## Instructions

---

### SV Series features overview

#### Power SMART

Welcome to the eco-friendly world of power smart spa controls with the SV Series from SpaNET™. Sophisticated real-time current sensing and variable heater technology allows the SV to make optimum use of any available power supply. Multi-phase capable, the SV Series also provides flexibility with connection to mains power supplies supporting connection to 1,2 or 3 phases from 10 to 60A. Add in the host of exclusive PowerSMART energy saving features such as the dedicated heat pump interface, Dynamic Thermal Tuning, Off-Peak PowerSAVE software, and user-adjustable heating modes and the SpaNET™ SV Series stands apart from all rivals as the most power efficient spa control available that provides the lowest possible daily operating cost.

#### Variable heater

Most SV Series controller models feature SpaNET's innovative variable heater technology. With real-time current sensing the variable heater will automatically alter its power level (kW) to match the residual power available (amperage) after considering any operating accessory loads (i.e. jet pumps, air blowers). The benefit is that you can take advantage of a larger heater size for faster heat recovery and rest easy knowing this same heater will automatically reduce its size to maximise heating input when accessory loads are operating. The variable heater is automatically controlled and does not require adjustment. SV Series spa controller models that include the variable heater can be identified by a "-VH" suffix to the controller model number (i.e. SV3-VH).

#### Heat pump interface

The SV Series spa controls are the first in the world to feature a dedicated expansion module for seamless integration of an energy efficient heat pump to the spa heating / cooling control system. The SV heat pump interface revolutionises spa temperature

\*Information is subject to change without notice.



# Features Overview

## SpaNet™ SV2, SV3 & SV4

---

control. We can now offer both automatic heating and cooling of the spa water (from 10°C - 40°C) all conveniently controlled via the spa-side keypad, whilst also providing greatly reduced heat recovery times which can be further reduced with the exclusive SV element boost and fast heat up cycle options. The SpaNET™ SV heat pump technology maintains your spa's water temperature using around 75% less energy than a conventional electric heater resulting in an eco-friendly and amazingly cost efficient appliance. If connected, the heat pump will automatically be controlled by the SV Series spa controller. If the temperature is adjusted the control system automatically responds and will use the heat pump to heat or cool where required to regulate the water to the new set temperature point. With solid state diagnostics and real time heat pump monitoring the SV series control system correctly looks after every need of the heat pump ensuring long term reliability whilst delivering absolute minimum operating costs.

### **Dynamic thermal tuning**

No two spas are the same when it comes to thermal performance and heat retention. The SV control system will automatically adapt and tune itself to the thermal properties of your spa pool in its environment, day to day, season to season, to reduce demand heat cycling. Dynamic Thermal Tuning provides optimal thermal regulation whilst minimising power usage, resulting in lower daily operating costs.

### **Power SAVE (Off-peak filtration and heating)**

Enjoy the benefits of greatly reduced off peak power tariffs to lower your spa's daily operating cost. The SV PowerSAVE technology controls automatic power consumption to off peak times whilst maintaining spa water temperature and daily filtration times. Simply enable PowerSAVE and set the tariff times and begin saving money.

# Water Priming Mode

## SpaNet™ SV2, SV3 & SV4

---

### TIPS ON FILLING SPA

- Before filling remove spa cabinet panel and be sure that all valves in the plumbing system are fully open to maximise the amount of air that can escape the pipe work during filling.
- Remove filter cartridge(s) before filling and be sure to fill the spa through the filter itself to flood the pipe work with water and minimise the chance of air pockets forming in the plumbing during the filling process.
- DO NOT fill spa by placing hose in the foot well. Filling a spa this way will create a large number of air pockets in the pipe work and may cause difficulty when priming. Always fill spa through the filter area.
- Once the spa is filled to the correct level attempt to power up the spa with the filter cartridges still removed. Verify that the spa controller completes its priming sequence and begins normal operation. Once normal operation has been verified turn mains power off, re-install filter cartridge(s) and restart spa.

### WARNING

**RESTRICTION OF WATER FLOW DUE TO DIRTY FILTER CARTRIDGES IS THE MOST COMMON CAUSE OF ER-3 FAULTS. IF THE SPA POOL HAS BEEN OPERATING NORMALLY THEN INTERMITTENT ER-3 FAULTS START TO OCCUR THE FILTER CARTRIDGE(S) WILL REQUIRE SERVICING.**

DEPENDING ON TYPE OF FILTER CARTRIDGE(S) INSTALLED THE FILTERS WILL EITHER REQUIRE CLEANING, SOAKING IN A FILTER CARTRIDGE DEGREASER SOLUTION OR REPLACING. REFER TO SPA RESELLER / MANUFACTURER FOR DETAILS ON TYPE OF CARTRIDGE INSTALLED AND RECOMMENDED CLEANING FREQUENCY & METHODS.

\*Information is subject to change without notice.

# Water Priming Mode

## SpaNet™ SV2, SV3 & SV4

---

Every time the power is turned on the SV controller will initiate a water priming sequence on start up. During a priming sequence the filtration pump will run for up to 20 seconds at a time in an attempt to purge air from the plumbing. The keypad display will scroll PRIMING during this sequence.

If the spa controller is successful in clearing all of the air from the heater tube the system will begin normal operation. However if air is still detected the spa controller will shutdown and latch on fault code (ER3-Water Prime, page 131).

### How do I solve ER-3 WATER PRIME:

- Press Pump  button to retry water priming sequence
- Check spa is filled to correct operating level as advised by spa manufacturer (refill if necessary)
- Remove filter cartridge(s) and retry water prime
- With mains power turned OFF, bleed airlock from pipe work by slightly loosening couplings on front of filtration pump and allowing air to escape
- With filter cartridge(s) removed use hose to flush water down pipe work in an attempt to clear the air pockets from the plumbing

### IMPORTANT NOTE

*Do not allow the filtration pump to continue to run after five (5) x failed priming attempts. Operating a pump without water for extended periods may cause damage to the pump. Turn power off, wait ten (10) minutes and then try again later.*

# Display Modes

## SpaNet™ SV2, SV3 & SV4

The in-heater water sensor constantly monitors the presence of water in the heater tube. If at any time air bubbles are detected the spa controller will automatically cancel all current operations and force a water priming sequence to begin. This will occur whether the spa is in automatic mode or manual use. If the priming sequence is successful in clearing the air pockets from the plumbing normal spa operation will resume in automatic mode. If unsuccessful the spa controller will shut down and latch on fault code ER-3 Water Prime.

### Display modes

Water Temperature / Set Temperature / Time

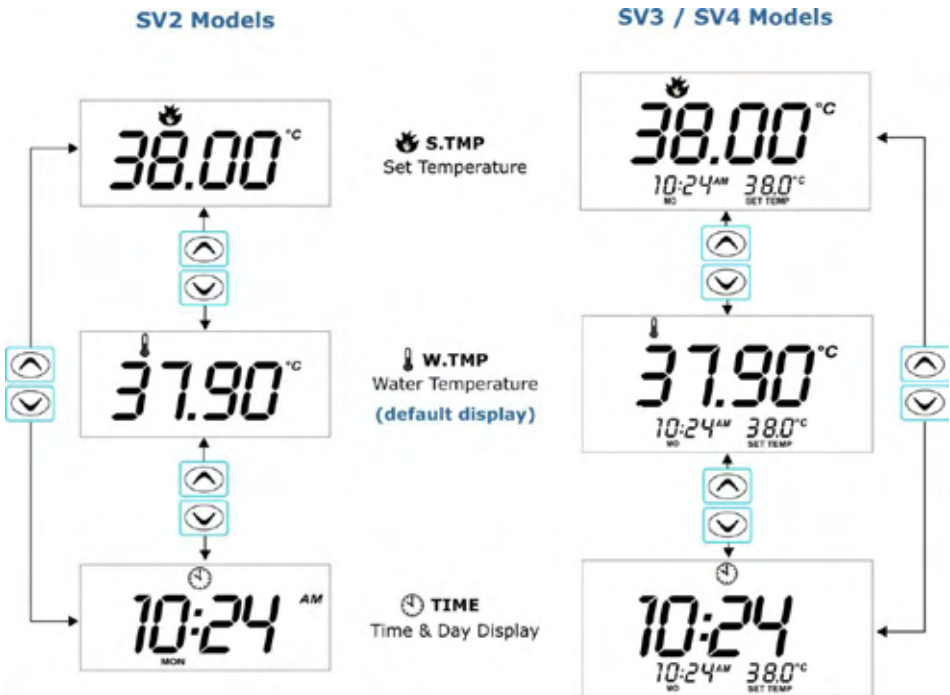

\*Information is subject to change without notice.



# Display Modes



## SpaNet™ SV2, SV3 & SV4

### IMPORTANT NOTE

- A ten (10) second idle time out period exists on non-default display modes. If the display mode is changed the screen will time out and return to the default display after ten seconds of idle activity has elapsed (i.e. no button presses).
- At times the WTMP icon will not appear and the temperature reading may take a while to update. This is normal and results from the SV control updating and performing dynamic thermal tuning to your spa and its environment. If this occurs, **the filtration pump may need to run for up to ten (10) minutes before the WTMP readout is refreshed.**

The SV keypads feature three different display modes to select from:

Mode	Icon	Description
W.TMP		Water Temperature
S.TMP		Set Temperature
TIME		Clock (Time & Day)

- The default display mode for all SV controller models is (W.TMP) Water Temperature.
- A short single press of the  or  button will navigate through the different display modes (refer illustrations aside).

# Display Modes

## SpaNet™ SV2, SV3 & SV4

---

- The purpose of the different display modes is to allow easy set temperature point and clock adjustment on all SV2/SV3/SV4 models.
- Please note the display mode icon at the top of the screen. These icons denote what display mode is currently being viewed.

### Other display icons



#### Filtration Cycle

The spa is performing a filtration cycle



#### Sanitise Cycle

The spa is performing an automatic or manual sanitisation cycle



#### Keypad Locked

The keypad has been locked



#### System Error

A fault has been detected. The system has halted operation so that corrective action can be taken. Take note of scrolling error code and consult trouble shooting section of this manual.

## Setting the date and time

Be sure to set the date and time before operating the spa. Vital functions such as filtration, sanitisation cycles and power saving settings depend on the time and date being set correctly.

\*Information is subject to change without notice.

# Setting Day/Time

## SpaNet™ SV2, SV3 & SV4

How to program the clock

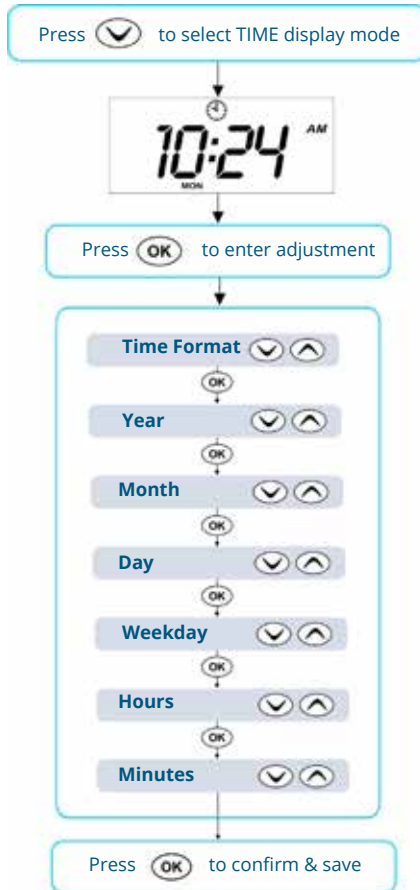



\*Information is subject to change without notice.

# Setting Day/Time

## SpaNet™ SV2, SV3 & SV4

---

### Steps:

- Press the  button to change display mode to TIME
- Press  to enter clock adjustment
- The settings appear in the following order:

### TIME & DATE

Format (24 hr / 12 hr)

Year (yyyy)



Month (mm)

Day (dd)

Weekday (mon – sun)

Hours (xx:00)

Minutes (00:xx)

- Press the  or  button
  - to set year, month, day, hours and minutes
  - to change between 24-hour format and 12-hour format
- Press the  button to save each setting and move to the next setting

### IMPORTANT NOTE

- *Leap years are taken into account*
- *Daylight savings times are NOT taken into account. The clock will NOT automatically adjust. It must be changed manually*
- *The real time clock will continue to operate when mains power is off for a period up to 16 hrs*

\*Information is subject to change without notice.



# Adjusting Set Temperature Point

## SpaNet™ SV2, SV3 & SV4

How to program the desired water temperature



The SV series spa controllers have been designed with simplicity in mind. The intelligent software constantly monitors the spa water, automatically controlling the heater and/or heat pump (if fitted) to ensure the desired set water temperature is maintained and required level of daily filtration achieved.

With set-and-forget technology, the spa user simply selects their desired water temperature (Range: 10°C - 41°C; Default: 38°C) and thereafter the SV controller will automatically

\*Information is subject to change without notice.

# Adjusting Set Temperature Point

## SpaNet™ SV2, SV3 & SV4

---

heat to and maintain that selected water temperature. This is called demand heating - the filtration pump and heater will be activated as required to maintain the set water temperature. The time spent heating the spa and running the pump under normal operation will be taken into account and where required the filtration pump will run for additional periods throughout the day to maintain the minimum level of daily filtration.

Dependant on the amount of normal spa use, set water temperature, daily filtration times, and climatic conditions being experienced, the SV controller will engage the heater and/or heat pump (if fitted) for differing periods of time, at differing times of day. The advanced software constantly monitors and recalculates after each heating/filtration cycle to ensure the correct daily filtration time is achieved and desired set water temperature is maintained.

### IMPORTANT NOTES

- *During a heating cycle the SV controller may raise the water temperature up to 0.6°C above set temperature point to provide an average water temperature of set point at most times.*
- ***If an optional heat pump is NOT fitted** the spa controller has **NO** ability to cool the spa water. Lowering the set temperature point will **NOT** cause the water to cool.*
- ***If an optional heat pump IS fitted** the spa water **CAN** be cooled as well as heated. Lowering the set temperature point will ensure the heat pump engages/disengages a cooling cycle (if required) to maintain the desired set water temperature.*

*If the spa control has been in standby mode (idle) for some time and the set temperature point is adjusted, the filtration/circulation pump may run for up to ten (10) minutes before the heater / heat pump engages to heat or cool (heat pump only) the water.*

\*Information is subject to change without notice.

# Heater Operating Modes

## SpaNet™ SV2, SV3 & SV4

### Normal / Away / Week Modes

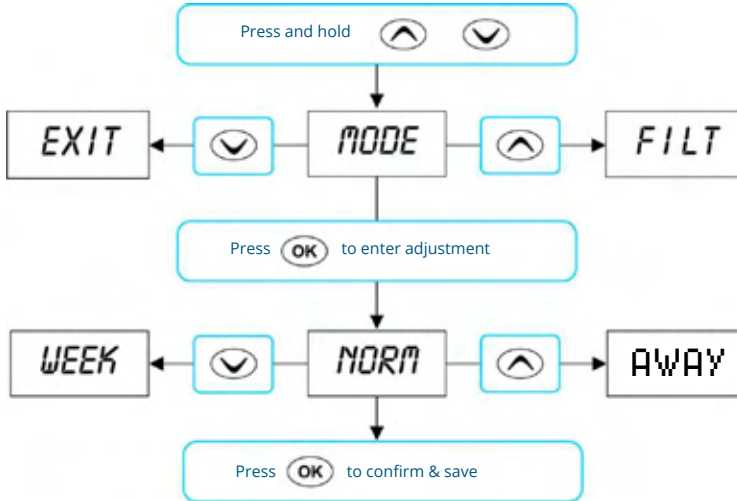

#### IMPORTANT NOTES







- *If Away mode is selected all heating is completely disabled. The heater will not engage unless the water temperature falls below 4°C and freeze protection activates.*
- *If a heat pump is fitted and demand cooling is required to maintain the set water temperature, the demand cooling will also be governed by the heating operating modes in the same way that demand heating is.*

# Heater Operating Modes

## SpaNet™ SV2, SV3 & SV4

The SV controllers feature four different operating modes that effect demand heating and filtration behaviour (refer table below).

Item	Mode	Notes
NORM	Normal	Normal operation for demand heating and filtration
AWAY	Away	Demand heating is DISABLED. Filtration is fixed at 1 hour per day (the keypad will scroll "AWAY MODE" every 60 secs)
WEEK	Week	Monday to Thursday: Demand heating is DISABLED and filtration fixed at 1 hour per day. Friday to Sunday: Normal Operation

- Press and hold  and  buttons together until [MODE] is displayed
- Press  button to enter operating mode (MODE) adjustment
- Press  or  to select desired operating mode
- Press  button to confirm and save setting

\*Information is subject to change without notice.

# Heater Operating Modes

## SpaNet™ SV2, SV3 & SV4

---

### IMPORTANT NOTES

- *The Week mode is ideal for spas used only on weekends or located at weekend holiday homes. To minimize operating costs during the week (when the spa will not be used) demand heating is disabled and filtration is reduced to 1 hour per day. During Friday, Saturday and Sunday the spa controller will operate as if in normal mode.*
- *If Week mode is selected, the spa controller will obey all programmed values (set temperature, sleep timers, power save timers, filtration etc) on Friday, Saturday and Sunday. Depending on current season and ambient temperatures the spa water temperature may fall significantly during Monday to Thursday when demand heating is disabled. The spa user must take into consideration all programmed settings including sleep timers and power save timers for the spa to have sufficient time to reheat to set temperature point on Friday (refer page 119 Setup Menu for further details on programmable settings).*

# Heating Control & Protection

## SpaNet™ SV2, SV3 & SV4

---

### Fast Heat Cycle / freeze and overheat protection

#### Fast heat cycle

After initial mains power on the SV controller will perform a fast heat up cycle that enables continuous demand heating regardless of programmed sleep timers or choice of or Normal (NORM) heating modes. Once the set temperature has been reached the fast heat up cycle is cancelled and normal operation resumes.

The purpose of a fast heat up cycle is to help the spa reach set temperature as soon as possible after it has been powered up. For new spas or spas refilled with cold water it is desirable not to have sleep time or economy heating mode delay the time it takes for the spa to reach set temperature point.

Note: AWAY mode disables a fast heat up cycle.

#### IMPORTANT NOTES

- *A fast heat up cycle is cancelled by manually forcing the filtration pump to OFF via the keypad.*
- *For new spas or when a spa has just been refilled it is common for spa owners to test the operation of each pump when the power is first turned on. This process will effectively cancel the fast heat up cycle. After completing testing of spa functions remember to reset mains power if you wish to reactivate the fast heat up cycle.*

\*Information is subject to change without notice.

# Heating Control & Protection

## SpaNet™ SV2, SV3 & SV4

---

### Freeze protection

Freeze protection will be activated whenever the water temperature drops below 4°C. It runs back to back 10 minute sanitise cycles and displays “WARM” on the LCD. It also runs each spa accessory (ie. jet pumps and air blower) in sequence to run water through the pipe work whilst running the filtration pump and heater. During the “WARM” cycle the heater and heat pump (if fitted) will operate however heater load shedding may occur when accessory pumps are running depending on controller settings.

At the end of each 10 minute “WARM” cycle the water temperature is checked. If it is above 4°C freeze protection stops and the controller returns to its prior state. If the temperature is not above 4°C another cycle will run.

**Note:** *Freeze protection overrides sleep time or power save times – if the water temperature drops below 4°C and the controller is in a sleep period it will wake up. So even if high amounts of sleep time, power save time and a low set temperature point have been programmed, the SV controller will always maintain the water temperature at least above 4°C.*

### Defrost cycle (heat pump models only)

During periods of low ambient temperatures defrost cycles may be required to prevent the heat pump’s condenser from freezing. Ambient and condenser temperatures are constantly monitored and defrost cycles will be automatically activated if certain conditions are met. Defrost cycles run for a minimum of 3 minutes to a maximum of 10 minutes.

# Heating Control Protection

## SpaNet™ SV2, SV3 & SV4

---

### Overheat protection

All SV controllers feature three forms of overheat protection:

- If sensed water temperature within the heater unit exceeds safe working limits the heating element will be disabled and the controller will shut down and latch fault code (ER4 - Thermal Trip, page 134). Normal operation will not resume until heater element has cooled and mains power is reset
- If sensed water temperature exceeds 42°C filtration is stopped until the temperature falls below 42°C to prevent heat rise from filtration pump operation
- If sensed water temperature exceeds 45°C the controller will shut down and latch fault code (Er5 - Pool too hot). Normal operation will not resume until mains power is reset

\*Information is subject to change without notice.



# Pump Operation

## SpaNet™ SV2, SV3 & SV4



### Pump buttons

The jet pumps and/or filtration pump are controlled via the pump buttons on the keypad. The functions of the pump buttons change depending on pump configuration, however Pump-A button is mostly used to control the filtration pump.

The intention is to make best possible use of these buttons for all possible pump configurations. For every press of a pump button the display will temporarily show the selected pump state:

**ON / OFF / LOW / HIGH / AUTO**

and then revert to the default display mode. The most common pump configurations and button assignments are referenced in the next page table.

### IMPORTANT NOTES

- *In configurations where a pump button controls the filtration pump and the heater is ON and pump is to be turned OFF; the pump will turn OFF after a 5 second delay to allow the heater to cool down.*
- *If left running, pumps will turn off after a 30 minute time out period. Time out period can be adjusted from 10 to 60 minutes via the Setup Menu item T.OUT.*
- *If after manual spa use filtration pump is left OFF, controller will revert to automatic mode 15 minutes after the expiry of the T.OUT period.*

# Pump Operation

## SpaNet™ SV2, SV3 & SV4

### Keypad pump button assignments

PUMP CONFIGURATIONS					
MODEL	CIRC	PUMP1	PUMP2	PUMP3	PUMP4
SV2	no	1 spd	-	-	-
SV2	no	2 spd	-	-	-
SV2	yes	1 spd	-	-	-
SV2	yes	2 spd	-	-	-
SV3	no	1 spd	1 spd	-	-
SV3	no	1 spd	1 spd	1 spd	-
SV3	no	2 spd	n/a	1 spd	-
SV3	yes	1 spd	1 spd	-	-
SV3	yes	1 spd	1 spd	1 spd	-
SV3	yes	2 spd	n/a	1 spd	-
SV4	no	1 spd	1 spd	1 spd	1 spd
SV4	no	2 spd	n/a	1 spd	1 spd
SV4	no	2 spd	n/a	2 spd	n/a
SV4	yes	1 spd	1 spd	1 spd	1 spd
SV4	yes	2 spd	n/a	1 spd	1 spd
SV4	yes	2 spd	n/a	2 spd	n/a

\*Information is subject to change without notice.

# Pump Operation

## SpaNet™ SV2, SV3 & SV4

BUTTON ASSIGNMENTS			
PUMP A	PUMP B	PUMP C	PUMP D
pump1 (on/off/auto)	-	-	-
pump1 (low/off/auto)	pump1 (high/low)	-	-
circ pump (on/off/auto)	pump1 (on/off)	-	-
circ pump (on/off/auto)	pump1 (low/high/off)	-	-
pump1 (on/off/auto)	pump2 (on/off)	-	-
pump1 (on/off/auto)	pump2 (on/off)	pump3 (on/off)	-
pump1 (low/off/auto)	pump1 (high/low)	pump3 (on/off)	-
circ pump (on/off/auto)	pump1 (on/off)	pump2 (on/off)	-
pump1 (on/off)	pump2 (on/off)	pump3 (on/off)	-
circ pump (on/off/auto)	pump1 (low/high/off)	pump3 (on/off)	-
pump1 (on/off/auto)	pump2 (on/off)	pump3 (on/off)	pump4 (on/off)
pump1 (low/off/auto)	pump1 (high/low)	pump3 (on/off)	pump4 (on/off)
pump1 (low/off/auto)	pump1 (high/low)	pump3 (low/off)	pump3 (high/low)
pump1 (on/off)	pump2 (on/off)	pump3 (on/off)	pump4 (on/off)
circ pump (on/off/auto)	pump1 (low/high/off)	pump3 (on/off)	pump4 (on/off)
circ pump (on/off/auto)	pump1 (low/high/off)	pump3 (low/high/off)	-

\*Information is subject to change without notice.

# Air Blower Operation

## SpaNet™ SV2, SV3 & SV4

### IMPORTANT NOTE

*In some configurations if heater is ON, activating multiple pumps may cause the heater to load shed and turn OFF, or reduce element power (variable heater models). This is to keep the system within its maximum current limit. The heater will be reengaged or returned to full capacity as soon as the number of pumps running is reduced.*

## Air Blower Operation







### Blower button

The blower button is used to toggle the air blower ON/OFF and allow adjustment of the blower speed. The selected speed is saved and will be restored the next time the blower is turned on, for future ON/OFF use. Two modes of operation are provided:

### Variable speed mode

In this mode the blower speed can be manually adjusted to one of five (5) x different speed settings.

- Press  button once to activate blower in variable speed mode
- Display will flash VARI mode then present b.SP.D (blower speed) adjustment menu (refer illustration aside)
- Press  or  buttons to increase or decrease the blower speed (note: bar graph segments adjust with blower speed)
- Press  button to exit menu or wait for 10 second display time out
- Press  button a second time to turn blower off

\*Information is subject to change without notice.

# Air Blower Operation

## SpaNet™ SV2, SV3 & SV4

### Variable Speed Mode

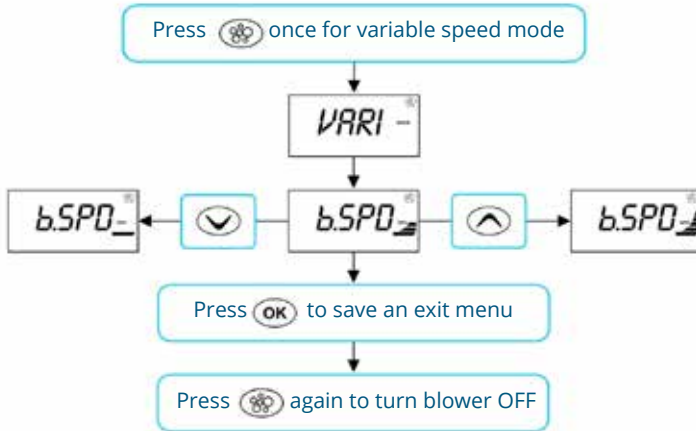

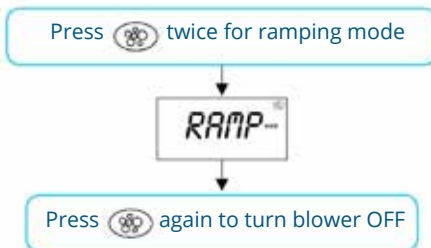

### Ramping Mode



### Ramping mode

In this mode the blower speed gradually increases and decreases through the blower speed range in a ramping manner.

- Press  button twice to activate blower in ramping mode
- Display will flash RAMP mode and blower operates in a ramping manner
- Press  button a second time to turn blower off

# Light Operation

## SpaNet™ SV2

### IMPORTANT NOTE

- When blower is turned on it runs at maximum speed for 3-4 seconds before changing to preset speed (this is normal)
- If left running, blower will turn off after a 30 minute time out period. Time out period can be adjusted from 10 to 60 minutes via the Setup Menu item T.OUT).

### Spa light operation (SV2.T models)

Multi-colour LED lighting effect modes

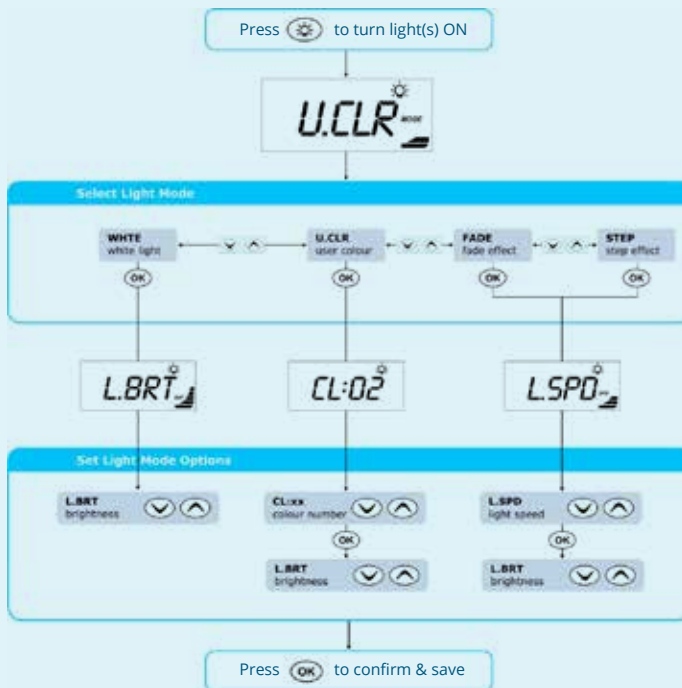

\*Information is subject to change without notice.







# Light Operation

## SpaNet™ SV2



### Light button

The light button is used to toggle the spa light(s) ON / OFF and to access the light mode menus. The features that can be adjusted are the light colour, light effect mode, light effect transition speed, and light brightness. All light settings are saved and will be restored the next time the light is turned ON, for future ON / OFF use.

- Press  button to turn light(s) on / off
- When light is turned on keypad will display light mode menu showing current light mode in use (refer illustration aside)
- Press  or  button to navigate through choice of light modes:
  - WHITE White Light
  - UCLR User Colour
  - FADE Fade Effect
  - STEP Step Effect
- Press  button to confirm light mode selection
- Dependant on light mode selected the keypad will display one of three light mode option screens (refer aside)
  - L.BRT Light Brightness
  - CL:xx User Colour Number (CL:00 - CL:20)
  - L.SPD Light Effect Transition Speed
- Press  or  button to adjust each setting
- Press  button to save each setting and move to the next setting

### IMPORTANT NOTE

- *When blower is turned on it runs at maximum speed for 3-4 seconds before changing to preset speed (this is normal)*

# Light Operation

## SpaNet™ SV3/SV4

### Spa Light Operation (SV3/SV4 Models)

Multi-colour LED lighting effect modes

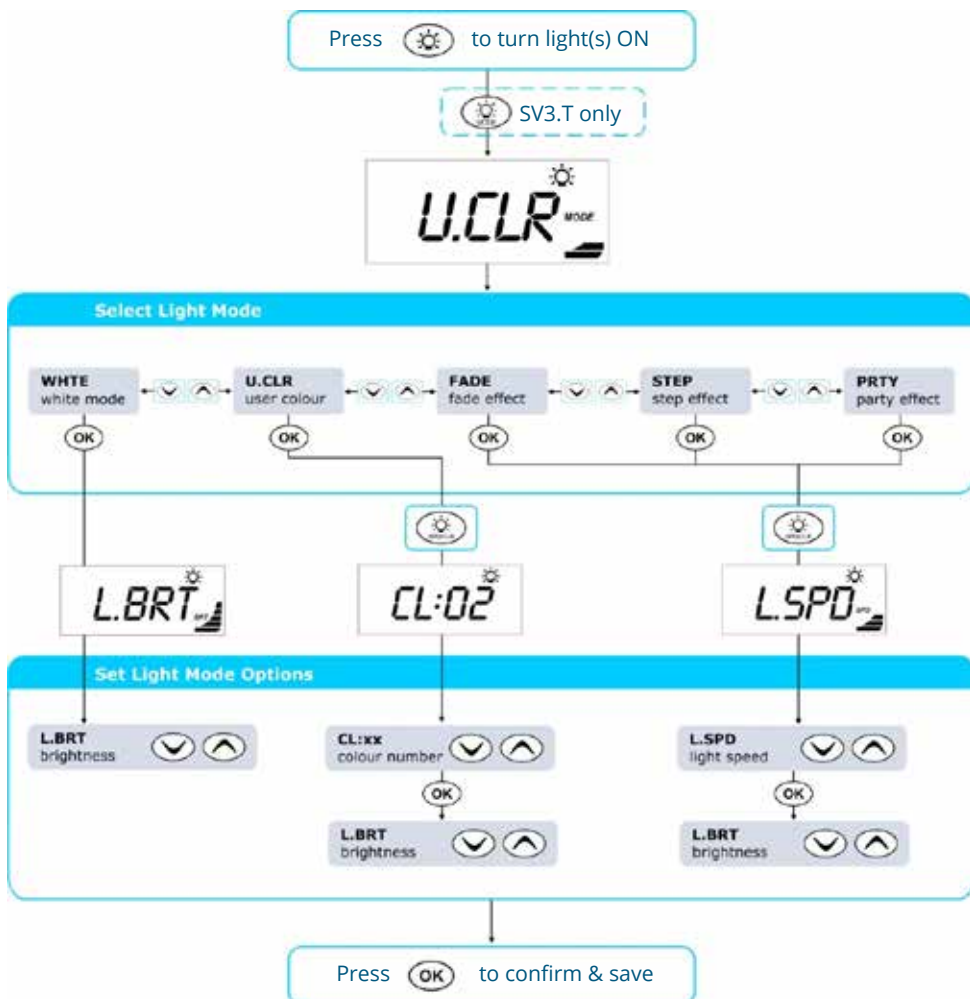

\*Information is subject to change without notice.











# Light Operation

## SpaNet™ SV3/SV4



### Light button

The light buttons are used to toggle the spa light(s) ON / OFF and to access the light mode menus. The features that can be adjusted are the light colour, light effect mode, light effect transition speed, and light brightness. All light settings are saved and will be restored the next time the light is turned ON, for future ON / OFF use.

- Press  button to turn light(s) on / off
- SV4.T models go straight to the next step  
SV3.T models => press  to access light mode menu
- Press  or  button to navigate through choice of light modes:
  - WHITE White Light
  - UCLR User Colour
  - FADE Fade Effect
  - STEP Step Effect
  - PRTY Party Effect
- Press  button to confirm light mode selection
- Press  to access light speed / colour menu
- Dependant on light mode selected the keypad will display one of three light mode option screens (refer aside)
  - L.BRT Light Brightness
  - CL:xx User Colour Number (CL:00 - CL:20)
  - L.SPD Light Effect Transition Speed
- Press  or  button to adjust each setting
- Press  button to save each setting and move to the next setting

### IMPORTANT NOTE

- *If left switched on, light(s) will turn off 15 minutes after the expiry of the pump/blower time out periods.*

# Sanitise Cycles

## SpaNet™ SV2, SV3 & SV4

Automatic and manual water clean cycles

Press  to activate sanitise cycle

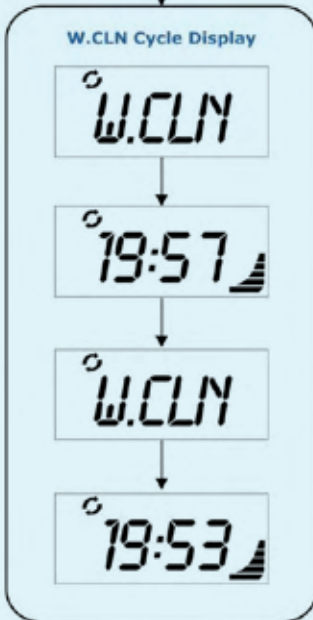

Whilst the cycle is running the display alternates between the W.CLN (water clean) title screen and the minutes remaining in the cycle (refer image).

### IMPORTANT NOTES

- *When the cycle is started automatic mode is enabled and if running any additional jet pumps and the blower are turned off.*
- *If the controller falls within a designated sleep or power save period during a sanitise cycle, the controller will not sleep until the sanitise cycle is finished.*

\*Information is subject to change without notice.



# Sanitise Cycles

## SpaNet™ SV2, SV3 & SV4



### Sanitise button

The sanitise button activates a twenty minute sanitisation cycle that runs the filtration pump and ozone / uv (if fitted) to filter the pool water to restore and refresh water quality. With circ pump systems jet pump1 will also run for the full 20 minute cycle. Where 2-speed filtration pumps are used the pump will run in high speed for the duration of the cycle. In addition, at the start and end of the cycle, the controller will sequentially (one at a time) run any additional pumps (pump2, pump3, pump4 if fitted) and the blower for one minute each to purge the plumbing and clear any unfiltered water trapped in those lines.

- Press  button to activate a 20 minute sanitise cycle
- Press  button again to cancel cycle (if desired)

### Automatic daily sanitise cycle

The controller will automatically run a 10 minute sanitise cycle every day at a user adjustable time (Default = 9:00am). The automatic sanitise cycle works in the same manner as a manual sanitise excepting that the cycle only runs for 10 minutes. This feature cannot be disabled – only the time this cycle is activated may be changed via the Setup Menu item W.CLN (refer page 123).

#### IMPORTANT NOTES

- *If the controller is in a sleep period at the specified automatic sanitise cycle time, it will wait until the sleep period ends before the sanitise cycle runs.*
- *If the spa pool is in manual use (i.e. the loads have not timed out and the spa has not returned to auto mode) at the time the automatic sanitise cycle is set to run the cycle will be cancelled for that day.*

# Special Function Buttons

SpaNet™ SV2, SV3 & SV4

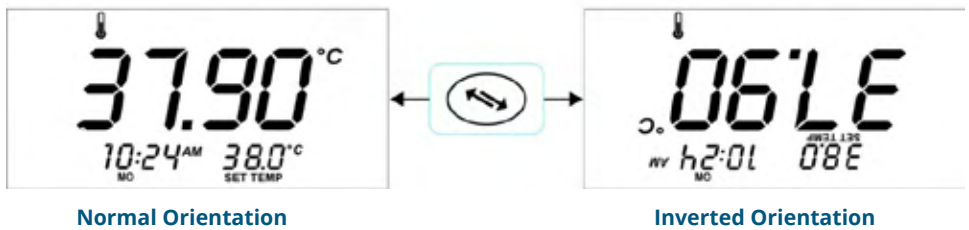
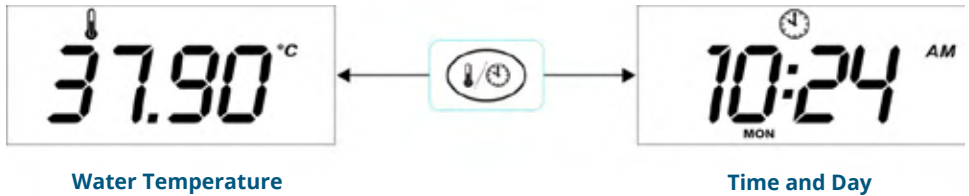

\*Information is subject to change without notice.

# Special Function Buttons

## SpaNet™ SV2, SV3 & SV4

### SpaNet™ SV2



#### Water temp / time toggle button

Featured on SV2 models only, this button is a shortcut key designed to quickly toggle the display mode between [W.TMP] Water Temperature or [TIME] Time & Day display modes.

### SpaNet™ SV3 / SV4





#### Invert display

On SV3 and SV4 model controllers the orientation of the keypad display can be inverted (flipped 180°) for easy reading in and out of the spa.

- Press  button to invert display orientation

### IMPORTANT NOTES

- *The operation of the  and  buttons also reverse to match the current display orientation.*
- *If the spa pool is in manual use (i.e. the loads have not timed out and the spa has not returned to auto mode) at the time the automatic sanitise cycle is set to run the cycle will be cancelled for that day.*

# Special Function Buttons

## SpaNet™ SV2, SV3 & SV4

Model specific function buttons

### Full Lock

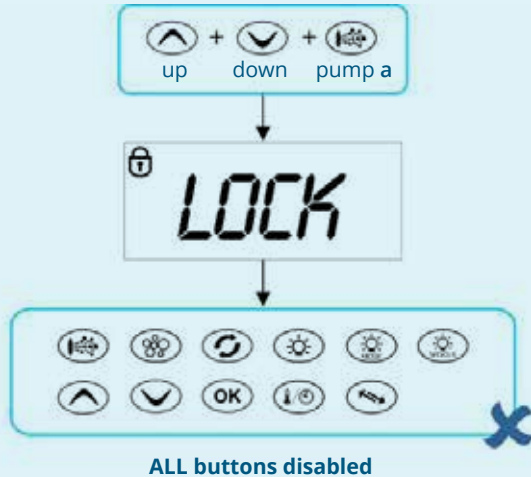

### Partial Lock

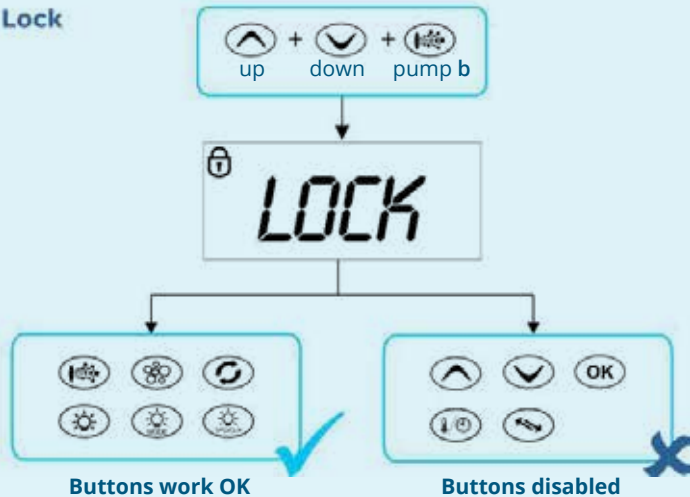

\*Information is subject to change without notice.

# Special Function Buttons







## SpaNet™ SV2, SV3 & SV4

The keypad buttons can be locked to prevent accidental key presses or to limit access to certain controller functions. This feature is particularly helpful when spa covers are used or where children are present.







There are two types of keylock:

- **Full Lock** all buttons are disabled
- **Partial Lock** allows use of pumps, blower, light and sanitise buttons however prevents adjustment of set temperature and other programmable settings

### Full lock

- Press and hold  +  +  until LOCK appears on the display  
up down pump a
- Once locked if any button is pressed the key stroke will be ignored and display will show LOCK (refer aside).
- To unlock keypad press and hold  +  +   
up down pump a

### Partial lock

- Press and hold  +  +  until LOCK appears on the display  
up down pump b  
Once locked only pumps, blower, light and sanitise buttons can be used.  
Access to all other buttons is disabled.
- To exit partial lock mode press and hold  +  +   
up down pump b

# Advanced Configurations

## SpaNet™ SV2, SV3 & SV4

### Set-up menu

How to program advanced configuration settings

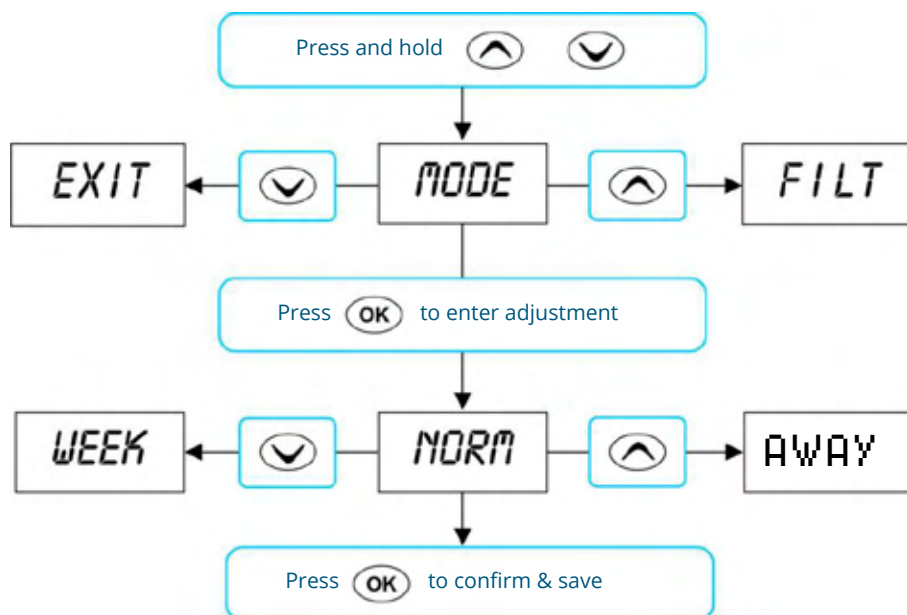

\*Information is subject to change without notice.











# Set-up Menu

## SpaNet™ SV2, SV3 & SV4

---

The SV controllers feature an advanced setup menu which allows customisation of the adjustable controller settings. Menu item options are detailed in the list below.

- To enter menu press and hold  and  buttons until [MODE] is displayed
- Press  or  to navigate through menu item list
- Press  to enter menu item adjustment
- Press  or  to adjust setting
- Press  to confirm setting and exit menu

### IMPORTANT NOTES

- *The setup menu item settings are stored in non volatile memory (EEPROM) and are remembered when power is turned off. No need to reprogram settings when power is restored.*
- *A ten (10) second idle menu time out period exists. If a button press is not detected for 10 seconds the menu will time out and the screen will return to the default display mode.*

# Set-up Menu

## SpaNet™ SV2, SV3 & SV4

Menu Item	Setting	Notes
MODE	Operating Mode	Normal / Economy / Away / Week Modes
FILT	Hours of filtration per day	1 to 24 hours
F.CYC	Filtration cycle blocks	Set filtration to run every 1,2,3,4,6,8,12 or 24 hrs
SNZE	Sleep time menu	
1.SNZ	Sleep timer 1	[1.DAY] Days of week, [1.BGN] Begin Time, [1.END] End Time
2.SNZ	Sleep timer 2	[2.DAY] Days of week, [2.BGN] Begin Time, [2.END] End Time
R.SET	Reset sleep timers	Reset sleep timers to factory defaults
EXIT	Exit sleep time submenu	
P.SAV	Power save settings	Off, Low (off-peak filtration), High (off-peak filtration & heating)
W.CLN	Automatic sanitise time	Daily run time of automatic sanitise cycle (00:00 - 23:59)
D.DIS	Default display mode	Water Temp (W.TMP), Set Temp (S.TMP) or Clock (TIME)
T.OUT	Load time out period	Pump / Blower time out period (10 to 60 minutes)
H.PMP	Heat pump operating mode	Auto (heat or cool) / Heat / Cool / Off (heat pump disabled)
H.ELE	Heat pump with SV element boost	On = Heat pump + SV element combined for heating Off = Heat pump only
EXIT	Exit setup menu	

\*Information is subject to change without notice.

# Set-up Menu

## SpaNet™ SV2, SV3 & SV4

### Setup menu item details

#### MODE Operating mode

The SV controllers feature four different operating modes that effect demand heating and filtration behaviour (refer table below).

Menu Item	Setting	Notes
NORM*	Normal	Normal operation for demand heating and filtration
AWAY	Away	Demand heating is DISABLED. Filtration is fixed at 1 hour per day (the keypad will scroll "AWAY MODE" every 60 secs)
WEEK	Week	Monday to Thursday: Demand heating is DISABLED and filtration fixed at 1 hour per day. Friday to Sunday: Normal Operation

\* Default Setting = NORM

#### FILT Filtration (hours per day)

Automatic filtration is provided to ensure that the pool water is filtered for at least a minimum time each day after considering how often the pool has had manual use or how long the filtration pump runs for water temperature maintenance. All time spent running the pump under normal operation (manual use, water temperature maintenance, sanitisation cycles) will be taken into account and where required the pump will run for additional periods throughout the day to maintain the minimum level of daily filtration as specified by the user. SV controllers support two different types of pump for heating and filtration.

\*Information is subject to change without notice.

# Set-up Menu

## SpaNet™ SV2, SV3 & SV4

### Filtration (hours per day)

The default filtration hours and adjustment limits differ for each pump type as follows:

	Small circ pump (2A or less)	Jet pump (2spd or 1spd)
Minimum filtration hrs p/day	1	1
Maximum filtration hrs p/day	24	8
Default filtration hrs p/day	4	3

### F.CYC Filtration Cycle Blocks (how often filtration cycles occur)

This setting allows the user to adjust the frequency of the filtration cycle(s). The user can set filtration blocks to occur every hour, right down to once a day, or somewhere in between.

Select filtration to occur every 1 / 2 / 3 / 4 / 6 / 8 / 12 or 24 hours

Default setting = 4 hrs (i.e. a filtration block will run every 4 hours)

### SNZE Sleep Timers

Programmable feature to disable automatic heating and filtration to stop all spa activity during certain times of day or night (refer detailed notes on page 125).

Default Setting = Sleep Timer 1 (Sat – Fri; Sleep period 22:00 – 07:00)

### P.SAV Power Save Setting (off peak filtration and heating)

Lower daily operating costs by programming either filtration only (LOW), or both filtration and heating (HIGH) to occur during off-peak power periods when the electricity rates are cheaper.

\*Information is subject to change without notice.

# Set-up Menu

## SpaNet™ SV2, SV3 & SV4

---

The setting choices are: OFF / LOW (off-peak filtration) / HIGH (off-peak filtration & heating)

Default Setting = OFF

### **W.CLN    Automatic Daily Sanitise Cycle Run Time**

SV controllers are automatically programmed to activate a 10 minute daily sanitisation cycle at a given time, where each pump/blower is operated to purge pipe work whilst operating the filtration pump. This setting allows adjustment of the start time of the automatic daily sanitise cycle.

Setting ranges from 00:00 to 23:59

Default = 09:00 (9AM)

### **D.DIS    Default Display Mode**

This setting allows adjustment of the default display mode. The d.DIS setting choices are:

W.TMP    Water Temperature    (Default on SV3/SV4 models)

S.TMP    Set Temperature        (Default on SV2 models)

TIME     Time & Day

### **H.PMP    Heat Pump Operating Mode**

This setting defines the heat pump mode of operation.

The H.PMP setting choices are:

AUTO    Heat pump will heat and cool (Default)

HEAT    Heat pump will only heat

COOL    Heat pump will only cool (SV element heating also disabled)

OFF     Heat pump disabled

# Set-up Menu

## SpaNet™ SV2, SV3 & SV4

---

### T.OUT Adjustable Load Time Out

All accessory loads (ie. jet pumps and/or air blower) automatically turn off after a time out period has elapsed. Fifteen (15) minutes later the lights will switch off and the pool will return to automatic mode. This setting allows the length of the time out period to be adjusted.

The T.OUT setting ranges from: 10 to 60 minutes

Default = 30 minutes

### H.ELE Heat Pump with SV Element Boost

This setting defines how the in-built SV electric heating element operates with a heat pump (if fitted). Set to OFF to disable electric heating. Set to ON to allow the SV electric element to boost heat pump heating if the water temperature is 2°C or more below set temperature point or the heat pump has been operating for more than 1 hour and setpoint has not been achieved.

The H.ELE setting choices are:

OFF SV element disabled (heat pump only)

ON SV element + Heat Pump for heating

Default = OFF

### EXIT Exit setup menu

#### IMPORTANT NOTES

- *If the ambient temperature is below the operational limit of the heat pump (-10°C) the in-built SV electric heating element will automatically be enabled regardless of the H.ELE setting.*

\*Information is subject to change without notice.

# Sleep Timer [SNZE]

## SpaNet™ SV2, SV3 & SV4

### [SNZE] Sleep Timer Menu

How to program sleep timers.

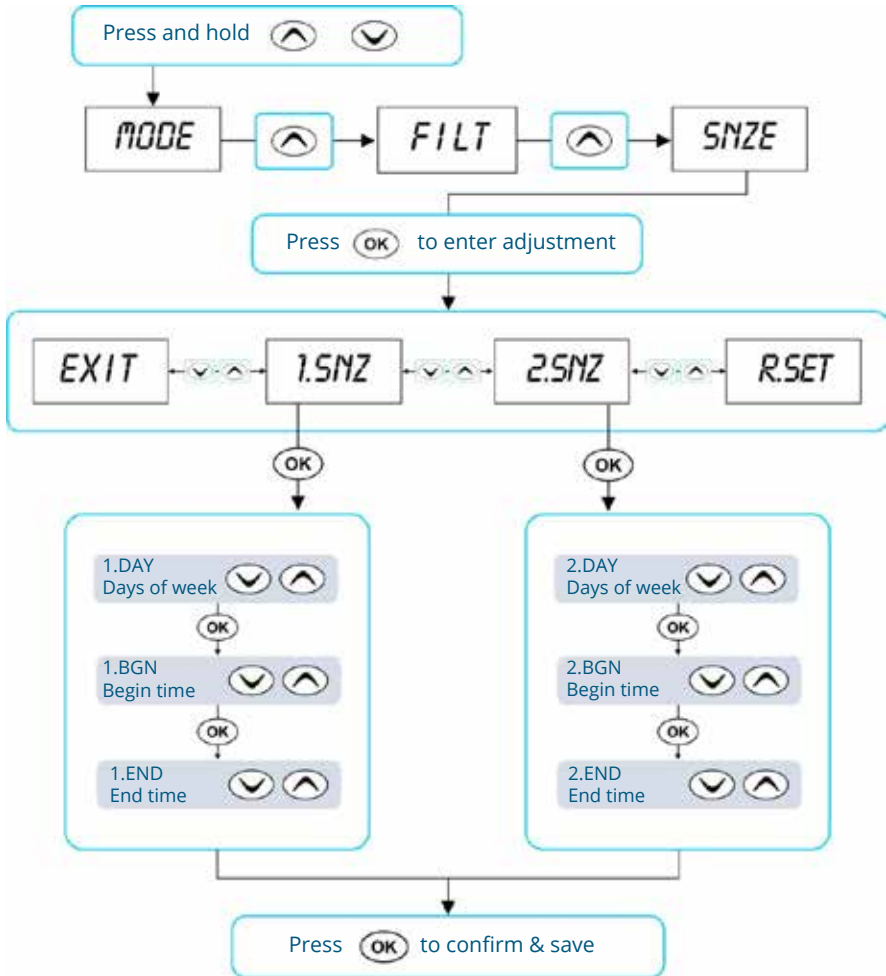

\*Information is subject to change without notice.

# Sleep Timer [SNZE]







## SpaNet™ SV2, SV3 & SV4

---

### How to program sleep timers

Accessed via the Setup Menu, Sleep timers are a very handy feature that enables the user to stop all spa activity during certain times of day or night. While the controller is sleeping NO automatic heating or filtration maintenance will occur, however the spa can still be operated by manual use without the need to adjust sleep time settings.

There are two individual sleep timers that can be set, each of which can operate on one or more specified weekdays. This enables the user to program different sleep times for different days (ie. weekdays vs weekends), as well as custom settings on a particular day/time where the user may want the spa silenced.

- Press and hold  and  buttons together until [MODE] is displayed
- Press  button until [SNZE] is displayed
- Press  button to enter sleep timers (SNZE) adjustment
- Press  or  to select from [1.SNZ] Sleep Timer 1; [2.SNZ] Sleep Timer 2; [R.SET] Reset sleep times to default; [EXIT] Exit sleep menu
- Press  button to confirm and move to the next setting

\*Information is subject to change without notice.



# Sleep Timer [SNZE]

## SpaNet™ SV2, SV3 & SV4

Each sleep time setting consists of a week day setting, start time and stop time (refer table below).

Item	Description	Notes
#.DAY	Selected day of operation	Sat / Sun / Mon / Tue / Wed / Thu / Fri Sat-Sun / Mon-Fri / Sat-Fri / : Default = Sat-Fri (Note : = disabled)
#.BGN	Begin Time Sleep time period begins	Adjustable: 00:00 - 23:59 Default = 22:00 (10PM)
#.END	End Time Sleep time period ends	Adjustable: 00:00 - 23:59 Default = 07:00 (7AM)

### IMPORTANT NOTES

- *There is a default sleep timer pre-programmed into each SV controller. By default: Sleep Timer 1 [1.SNZ] is set to operate every day of the week (Sat – Fri) with sleep period between 22:00 (10PM) and 07:00 (7AM)*
- *Sleep Timers will override any programmed PowerSAVE [P.SAV] times. Spa users must consider cancelling the default sleep timer when programming P.SAV times for off-peak heating and filtration (refer page 146)*
- *Freeze protection will override sleep timers*

# Power Save Setting [P.SAV]

## SpaNet™ SV2, SV3 & SV4

### [P.SAV] PowerSAVE Menu (off-peak)

How to program off-peak filtration and heating

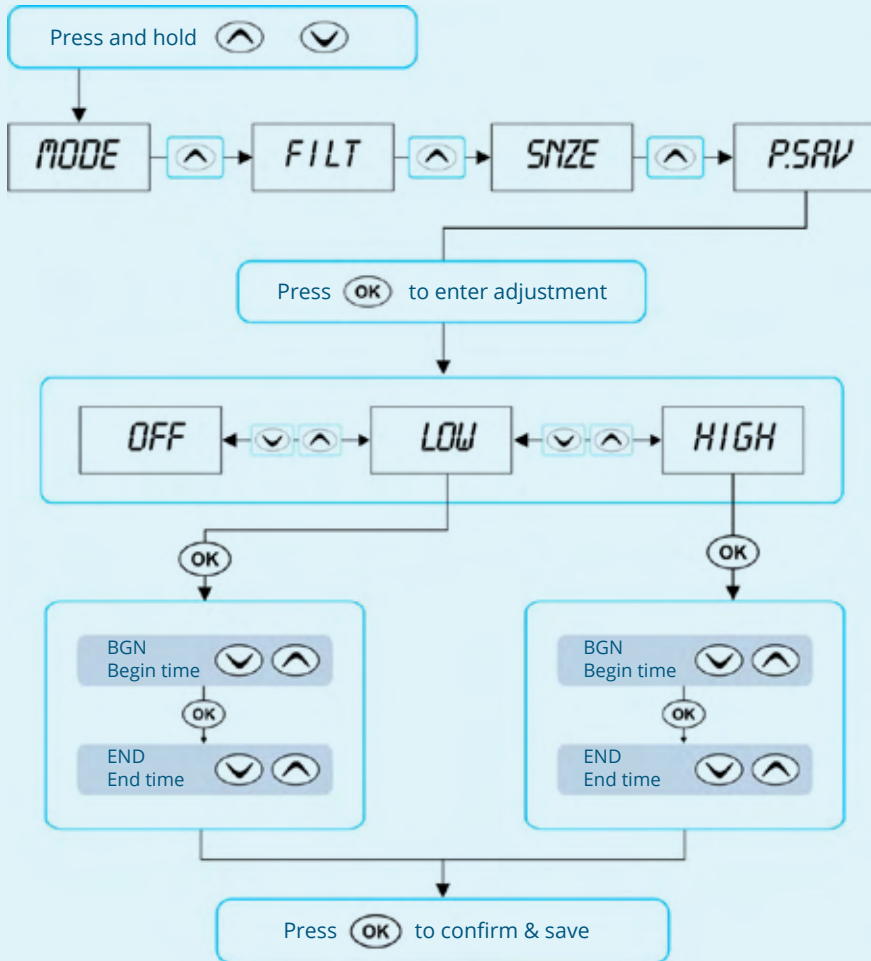





\*Information is subject to change without notice.

# Power Save Setting [P.SAV]



## SpaNet™ SV2, SV3 & SV4

Power utilities in some regions offer household power meters that can track power usage during different times of the day. This allows the utilities to offer greatly reduced power pricing during off peak power times. The Power Save (P.SAV) function allows the user to program in the peak power period so the spa control knows not to perform filtration and/or heating during those expensive hours. Instead the controller will take advantage of the competitively priced off peak hours, and run the filtration and/or heating during the off peak hours.

- Press and hold  and  buttons together until [MODE] is displayed
- Press  button until [P.SAV] is displayed
- Press  button to enter power save (P.SAV) adjustment

The power save setting consists of a choice of mode, peak power period start time and peak power period end time (refer table below).

Item	Description	Notes
P.SAV	Power Save Mode Functions disabled during peak power periods	<b>OFF = P.SAV disabled (default)</b> LOW = Filtration disabled HIGH = Filtration & Heating disabled
BGN	Begin Time Peak power period begins	Adjustable: 00:00 - 23:59 <b>Default = 14:00 (2PM)</b>
END	End Time Peak power period ends	Adjustable: 00:00 - 23:59 <b>Default = 20:00 (8PM)</b>

- Press and hold  and  buttons together until [MODE] is displayed
- Press  button until [P.SAV] is displayed

# Error Codes/Troubleshooting

## SpaNet™ SV2, SV3 & SV4

### IMPORTANT NOTE

- *If P.SAV function is to be used the spa user MUST consider any sleep timers [SNZE] and adjust them accordingly. Sleep timer settings will OVERRIDE any P.SAV settings. All SV controllers have a default sleep timer (Sat – Fri; Sleep period 22:00 – 07:00). If P.SAV is set and the default sleep timer is not adjusted the spa controller may have insufficient awake hours for water temperature maintenance. Refer to page 143 for further details regarding sleep timers.*

## Error Codes & Troubleshooting Problems

### How to troubleshoot spa problems

SV spa controllers feature self diagnostics and scrolling error messages to quickly troubleshoot possible problems. Should the spa control encounter a problem the error code / message will scroll across the topside panel screen until the problem is resolved.

If an error condition is experienced all spa functions are shut down and the spa should not be used until the error condition has been resolved. A list of error codes with descriptions of problems and possible solutions is detailed below for your reference.

### IMPORTANT NOTE

**For most error codes main power to the spa control must be turned OFF and then back ON before the error condition will be cleared.**

# Error Codes/Troubleshooting

## SpaNet™ SV2, SV3 & SV4

---

### Heartbeat LED

All SV model spa packs feature a red flashing heartbeat LED light. The heartbeat LED is located on the front right hand side of the spa pack itself (installed underneath spa skirt). The heartbeat LED flashes to indicate the current health/status of the spa pack. When the spa pack is functioning correctly with no errors to report the heartbeat LED emits a single flash in a constant pulse much like a heartbeat (ON, OFF, ON, OFF). If the spa pack encounters a fault the heartbeat LED will begin flashing in sequence with the error code number being experienced (ie. ER2 = ON,ON; OFF ON,ON; OFF).

If the keypad display is ever blank a spa user can still determine the health / status of the SV controller by removing a panel from the spa skirt and checking the heartbeat LED on the front of the spa pack itself.

### ER-2 HEATER PLUG

Problem: No heater sensor communication

Cause: Internal heater sensor communication problem

Solutions:

- Turn mains power OFF, wait 5 minutes then restart spa
- Contact spa reseller if problem is not resolved with power reset

### ER-3 WATER PRIME

Problem: Water prime failed – air detected in heater tube

Cause: Airlock in pipe work, low water level, dirty filter cartridges

Solutions:

- Press Pump A button to retry water prime
- Check spa water level (refill if necessary)
- Remove filter cartridges and press Pump A button to retry prime
- Bleed airlock from pipe work by slightly loosening couplings on front of filtration pump
- Remove filter cartridges and flush water down pipe work with a hose

# Error Codes/Troubleshooting

## SpaNet™ SV2, SV3 & SV4

---

### ER-4 THERMAL TRIP

**Problem:** Heater thermal trip activated. Heater has been active and has had insufficient water flow over the element. Low or no water flow has caused the heater temperature to exceed its maximum limits and the spa control has shut down operation to prevent any damage to the heater unit

**Cause:** Low water level, airlock in pipe work, closed shut-off valves, dirty filter cartridges, filtration pump failed or operation intermittent

**Solutions:**

- Turn mains power OFF and wait 10-15 minutes for element to cool and thermal cut-out device to reset. Then turn power back ON
- Check spa water level (refill if necessary)
- Remove filters and clean as per manufacturer's recommendations or replace cartridges if required
- Check under spa cabinet to ensure all shut-off valves are in the OPEN position
- Bleed airlock from pipe work by slightly loosening couplings on front of filtration pump or by removing filters and flushing water down pipe work with a hose.

### ER-5 POOL TOO HOT

**Problem:** Pool over temperature. Temperature sensor reading  $\geq 45^{\circ}\text{C}$  heater unit

**Cause:** High ambient temperatures (especially in summer months) have caused water temperature to rise above set temp point, Excessive filtration time, Jet pumps have been operating for extended periods with the spa cover still on.

\*Information is subject to change without notice.

# Error Codes/Troubleshooting

## SpaNet™ SV2, SV3 & SV4

---

- Solutions:
- Turn mains power OFF, remove spa cover, allow spa to cool then turn power back ON
  - Check daily filtration time (refer filtration section) and reduce daily filtration time if required
  - Check spa cover is not resting on topside panel buttons causing jet pumps to start when cover is on. Use keylock function to lock keypad buttons when spa not in use.

### ER-6 12V OVERLOAD

Problem: 12V (port) current draw over 1A limit

Cause: Total 12V current drawn by keypad(s), light(s), expansion ports and in pool temp sensor is excessive, 12V power supply is overloaded, too many LED light bulbs installed, faulty LED light. Turn mains power OFF and wait 10-15 minutes for element to cool and thermal cut-out device to reset. Then turn power back ON

- Solutions:
- Turn mains power OFF and restart spa to see if problem reoccurs
  - Reduce number of LED lights being installed
  - Systematically unplug lights, in pool temp sensor, keypads and expansion port loads from spa pack (one by one) to identify faulty part
  - Contact your spa reseller if problem persists

# Error Codes/Troubleshooting

## SpaNet SV2, SV3 & SV4

---

### ER-8 CTRL FAULT HVS

**Problem:** Heater relay is on when it should be off

**Cause:** Power surge, periods of low or high voltage, water on spa pack terminal block, relay problem

- Solutions:**
- Turn mains power OFF and back ON again to see if spa control recovers from ER8 fault
  - Inspect under spa cabinet for evidence of water leaking onto spa control. If water present, turn mains power OFF and isolate, then resolve leak, dry up excess water, and allow spa control to dry out before restoring power
  - Contact your spa reseller if problem persists

### ER-10 OVER CURRENT

**Problem:** Mains (230V) current draw above current limit (C.LMT) detected

**Cause:** Accessory devices current draw is too large for the C.LMT setting, faulty jet pump or air blower drawing excessive current, current limit (C.LMT) settings are not configured to match circuit breaker rating, load shed (L.SHD) and/or load limit (L.LMT) settings incorrect

- Solutions:**
- Turn mains power OFF and back ON again
  - Check operation of each pump => attempt to identify problematic pump or blower causing ER10 to occur
  - Contact your reseller to check controller settings are configured to match available power and circuit breaker rating

\*Information is subject to change without notice.



# Heat Pump Error Codes

## SpaNet™ SV2, SV3 & SV4

If an optional heat pump is fitted and a heat pump fault condition is detected a warning message is scrolled across the touch pad LCD every 60 seconds and the heat pump is disabled.

Spa operation will continue however the spa will now heat with the inbuilt SV electric element and there will be no ability to cool the water. The heat pump warning message will continue to scroll every 60 seconds, and the heat pump will remain disabled until the mains power is turned OFF and back ON again.

If after resetting mains power the fault condition persists please contact your spa and report the warning message that is shown. A list of the fault conditions and reseller warning messages are detailed below for reference.

WARNING MESSAGE	DESCRIPTION
"HEAT PUMP AMB"	Ambient thermistor temperature sensor error
"HEAT PUMP COND"	Condenser thermistor temperature sensor error
"HEAT PUMP FLOW"	Water flow not detected
"HEAT PUMP LOW P"	Compressor low pressure switch open
"HEAT PUMP HIGH P"	Compressor high pressure switch open
"HEAT PUMP COMP"	Compressor thermal cut out open
"HEAT PUMP EXCH"	Heat exchanger thermal cut out open

### IMPORTANT NOTE

- *If a heat pump encounters an error the heat pump will remain disabled until the mains power to the SV spa controller is turned OFF and back ON again. The heat pump warning message will continue to scroll every 60 seconds until the power is reset.*

# SpaNet™ Product Warranty

Unless otherwise specifically stated herein, all SpaNET™ control systems including topside panels (touch pads), heaters, and in pool temperature sensors manufactured by SpaNET Pty Ltd and that are supplied, pre-installed on a complete spa pool are warranted to be free from defects in workmanship and materials for a period of two (2) years from date of manufacture at SpaNET Pty Ltd. All pumps, heat pumps, air blowers and underwater lighting supplied by SpaNET Pty Ltd are warranted to be free from defects in workmanship and materials for a period of twelve (12) months from date of supply. All replacement spare parts supplied by SpaNET Pty Ltd are warranted to be free from defects in workmanship and materials for a period of six (6) months from date of supply.

## Warranty exclusions

This warranty or a claim made under it may be refused if the defect claimed has arisen for reasons other than faulty or defective parts or workmanship. Circumstances in which a warranty claim may be invalidated include, but are not necessarily limited to the following:

1. Product or component failures caused by improper water maintenance resulting in abrasive/acid water
2. Damage caused by incorrect electrical installation, electrical brownouts, voltage spikes and/or surges, lightning strikes, or operating the system outside of the specified voltage range by more than +/- 5%
3. Incomplete or improper installation of SpaNET™ products
4. Operating SpaNET™ products on an extension lead
5. Damage caused by misuse, abuse or neglect including failure to properly maintain
6. Damage caused by insect or vermin infestation
7. Acts of god
8. Water damage to products not installed in a suitable location or environment

\*Information is subject to change without notice.

# SpaNet™ Product Warranty

---

9. Water damage to products caused by but not limited to leaking pipes, pumps, unions and joints on the spa pool
10. Commercial use of SpaNET™ products reduces all warranties to a period of 6 months

## Warranty coverage

SpaNET Pty Ltd only extends this warranty to the original purchaser and only if the product has been purchased through an authorised SpaNET Pty Ltd reseller. Written notice and proof of purchase must be provided to SpaNET Pty Ltd or in some instances a representative nominated by SpaNET Pty Ltd within 14 days of the defect occurring. To action warranty contact the authorised SpaNET™ reseller you purchased from. Labour, travel and related costs and expenses for service calls in the field or at customer's site are also excluded and are not covered by this warranty. All products covered by this warranty must be returned for inspection and assessment freight prepaid to either SpaNET Pty Ltd or an authorised SpaNET Pty Ltd service centre. SpaNET Pty Ltd reserves the right to offer a repaired or replaced product where the warranty claim has been deemed to be warranty by SpaNET Pty Ltd. All other remedies of any kind are waived by the customer and specifically excluded from this warranty. Products sold by SpaNET Pty Ltd at No Charge are specifically excluded from this warranty. Where a warranty repair is carried out or parts/components are supplied under warranty, the warranty of such expires as per the original warranty period offered on the original product.

## Electrical connection

All electrical connections must be carried out by a qualified electrician. Failure to do so will immediately VOID this warranty. The SpaNET™ control system must be connected to a dedicated MAINS electrical supply circuit supplied through a residual current device (RCD) having a rated residual operating current not exceeding 30mA.

# WiFi & Audio Kit

## Safety Considerations

- Disconnect power to the spa before removing any cabinet panels.
- To reduce the risk of injury, do not permit children to install this product.

## Tools Required

- Battery-powered screwdriver
- Phillips screwdriver



## Included in your Kit

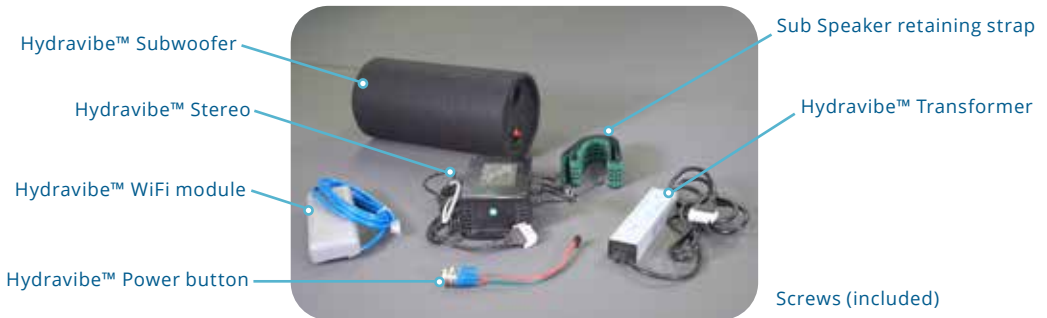

\*Information is subject to change without notice.

# SmartLink™ Wifi & SmartLink™ App

---

The SmartLink™ WiFi module and SmartLink™ app lets you use an Apple® or Android™ device to connect to and take control of your spa remotely from any location at any time. The SmartLink™ module connects to any model SV controller and then uses your home WiFi network to facilitate communication between the app server and the spa. The SmartLink™ app becomes a mobile, wireless remote for your spa, enabling complete control of all settings and accessories including pumps, blowers and LED lights.

The SmartLink™ module is compatible with all model SV controllers (SV2/SV3/SV4/SV Mini 1 & 2) produced from 2015 or later. The SmartLink™ app offers push notifications for spa status updates and allows you to request global remote technical support for your spa if required. Both features can be turned on or off via the app settings.

For a smooth and successful setup process you must complete each installation section and steps in their correct order:

1. Install SmartLink™ WiFi Module
2. Confirm WiFi Internet access credentials
3. Download and install the SpaNET™ SmartLink™ app
4. Register a User Account
5. SmartLink™ app setup process

**Note:** *A strong and stable WiFi connection is required at your spa for this system to work.*

# Hardware Requirements

The SmartLink™ WiFi module must be connected to the EXP1 socket of a SpaNET™ SV Series spa control for the SmartLink™ app to work. The SmartLink™ WiFi module requires an active, permanent Internet connection via a wireless router to operate, and can only use the 2.4GHz band. Both the spa pool and the Internet connection/router must remain powered on at all times for the spa to remain online.



\*Information is subject to change without notice.

# SmartLink™ V2 & V3 Modules

There are two current generations of SmartLink™ modules available, the V2 and V3. Both use a similar enclosure and have similar features and performance. The V3 is distinguished by its darker grey colour and a small V3 stamp in the bottom right corner of the enclosure. Whilst the V3 benefits from Bluetooth functionality making the initial app setup process slightly faster and easier, once the app setup is complete, either of the V2 or V3 modules will perform equally well on our app servers providing you finger-tip remote control of your spa pool.

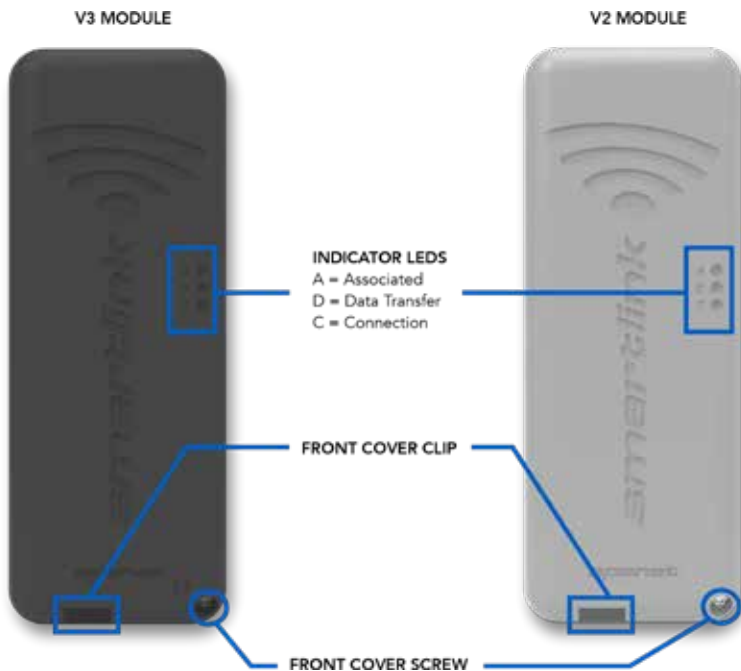

## V3 Module Specifications

2.4GHz 802.11 b/g/n  
Bluetooth v4.2 BR/EDR  
No character restrictions on passwords

## V2 Module Specifications

2.4GHz 802.11 b/g  
% character not supported in passwords  
Spaces also not supported in passwords

\*Information is subject to change without notice.

# WiFi & Audio Kit Installation

**Step 1: Locate the equipment bay in your spa.** Sun & Soul® spas have their equipment bay located directly under the keypad. However, that is not always the case in all models. To check your spa equipment location, see the Sun & Soul® Owner's manual.

Your Sun & Soul® spa will come with two pre-drilled holes on the cabinet. One, for the On/Off switch Audio system, and another hole to feed the cable through to the WiFi model. The pre-drilled holes comes with blanking caps pre-install.

If you are not using Sun & Soul® Spa WiFi and Audio Kit, leave the caps in the holes.

**Step 2: Remove cabinet panel to access black box.**



**Step 3: Mounting the transformer & stereo.**

Once the cabinet panel is removed. Find the black box where you will mount the stereo and transformer. It already has the Ozone generator mounted in it.



\*Information is subject to change without notice.



# WiFi & Audio Kit Installation

**Note:** *The Sun & Soul® WiFi and Audio Kit comes with two different length set of screws:*

- *Longer screws, for securing down the Sub Speaker.*
- *Small screws, are used for mounting the Stereo & Transformer into the black box.*

*Using the right size of screws is essential. The pipe behind the black box can be pierced if you use larger screws.*

**Step 4:** Use two small screws to attach the transformer.



**Step 5:** Using four small screws attach Amplifier to the black box.



# WiFi & Audio Kit Installation

Step 6: Connect speaker cables 3, 2 and 1.



Step 7: Connect power supply to amplifier.  
Connect the white two-pin connectors.



Step 8: Connect power supply to the SpaNet™ controller

The two outside pins of the connector have flat sides, meaning you can plug in only one way.

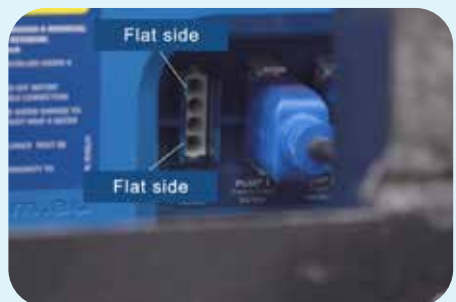
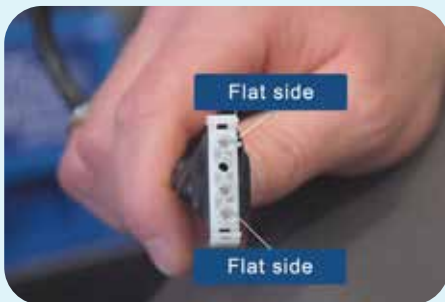

\*Information is subject to change without notice.

# WiFi & Audio Kit Installation

## Hydravibe™ Subwoofer

Connect power supply to SpaNet™ controller.



**Note:** *Install the Audio WiFi Kit before fixing the spa into position.*

- *The subwoofer mounting location is different for each spa; see page 20 of the Sun & Soul® Owner's Manual - Equipment Location, for the drawings showing the placement of the sub-speaker for each model.*
- *Audio & WiFi Kit optional upgrade is not available in SOUL100™ and SOUL200™ models.*

**Step 9:** Locate and remove cabinet panel to access the subwoofer mounting plate. See owner's manual, for your spa model equipment location.



\*Information is subject to change without notice.

# WiFi & Audio Kit Installation

## Hydravibe™ Subwoofer

### Step 10: Mount the subwoofer using the provided strapping.

Place the subwoofer over the speaker base plate. Using the strape included in the kit, bring the strap over the subwoofer and screw the strapping down.



**Note:** You might have to pull out one of the side panels of your spa to run the cables around to the subwoofer location.  
(See Sun & Soul® Owners Manual for your spa equipment location)

### Step 11: Insert positive and negative wires into amplifier. Re-attach cabinet panel.

Put the red wire into the red section, push down the red tab and push the wire in. Repeat for the black wire. Make sure the wires are sitting in place.



\*Information is subject to change without notice.

# WiFi & Audio Kit Installation

## Module Installation

---

In most instances your SmartLink module will be pre-fitted under your spa cabinet or assigned to a designated place by your spa manufacturer. Dependant on spa and module location, orientation, number and type of walls between spa and router, router signal output quality and strength, insulation material used on spa cabinet and other factors, the WiFi signal received under the spa cabinet may or may not be strong enough for reliable operation.

The SmartLink module has been designed as an external unit, so if WiFi strength is weak or your module has not been pre-fitted to your spa please consider the below points before determining your final installation location.

**Locate SmartLink module in position with best line of sight to router.**



# WiFi & Audio Kit Installation

## Module Installation

If the spa is located in a pit or under decking, locate module above ground in a weather protected area with line of sight to router.

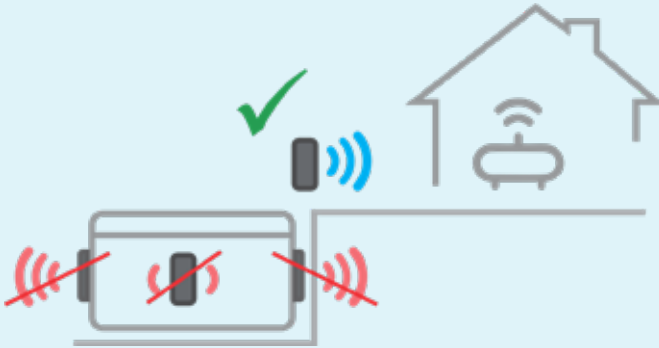

**Note:** Longer data cable may be required. Do not extend existing data cable, replace if longer length required, maximum cable length = 10m.

Module must be orientated vertically to receive adequate signal strength with WiFi logo at top to maintain water protection.



\*Information is subject to change without notice.

# WiFi & Audio Kit Installation

## Module Installation

---

### Step 12: Mount the SmartLink™ module on the cabinet panel.

Locate the two pre-drilled holes on your spa cabinet panel. Remove the caps. And unscrew the cabinet panel.



Push the SmartLink™ connector cable through one of the holes.



Use the adhesive backing from the module to secure it into the spa cabinet.



# WiFi & Audio Kit Installation

## Module Installation

---

Attach the module vertically to the cabinet panel covering the pre-drilled hole.



**NOTE:** *The module MUST be positioned in a vertical orientation, with the WiFi symbol at the top to maintain waterproofing and for best signal strength.*

### Step 13: Installing On/Off button.

First, remove the button plug from the ON/Off button by pressing the latch on the back and pull the button out.

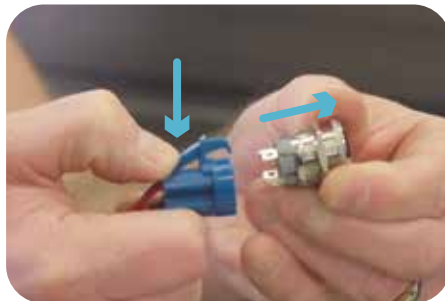

\*Information is subject to change without notice.



# WiFi & Audio Kit Installation

## Installation On/Off button

---

Remove the fastening nut from the back of the On/Off button so the button can be pushed through the cabinet panel.

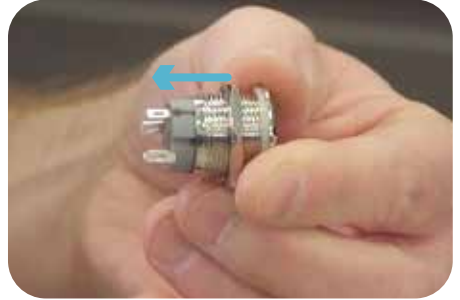

Fix the button using the locking nut to secure it to the back of the cabinet panel.

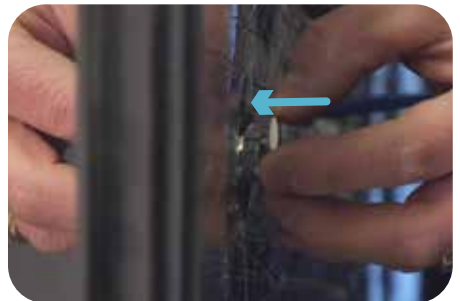

# WiFi & Audio Kit Installation

Complete the final connection by plugging the button into the connector on the back.



## Step 15: Connect the SmartLink™ antenna into the SpaNet™ controller.

To connect the SmartLink™ module to the controller.

Remove the screws from the front of the SpaNet™ controller panel to access.

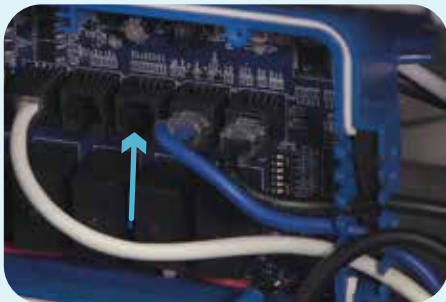

Expansion port 1 is the third port from the right. Also, labeled underneath the port as Exp 1.

\*Information is subject to change without notice.

# WiFi & Audio Kit Installation

Insert the SmartLink™ cable into Exp 1. Make sure it connects properly, then run the cable through one of the gaps in the side cord grip.

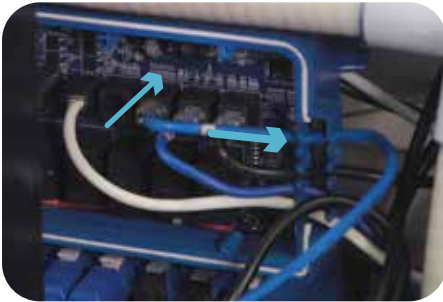

EXP1  
socket  
only



Re-attach the SpaNet™ controller panel.

\*Information is subject to change without notice.

# WiFi & Audio Kit Installation

Step 16: Connect the On/Off cable to the stereo lead.

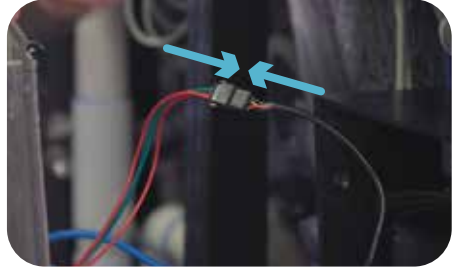

Step 17: Re-attached cabinet panel. The installation of your spa WiFi and Audio Kit components is complete.



Step 18: Via Bluetooth, connect the smart device to the system. See page 26 for instructions on how to do it on different devices.

\*Information is subject to change without notice.

# WiFi Internet Access

## SSID Name and Router Password

---

The SmartLink™ WiFi module requires a permanent, active Internet connection via a wireless router to operate. To be able to access your spa from anywhere, at any time, the router must remain powered on at all times. WiFi signal strength is extremely important for stable, reliable app operation. If the WiFi signal is too weak, the app setup process may not be able to be completed or the spa could have intermittent connections and drop offs. In this situation the WiFi signal would need to be boosted/improved by either ensuring your SmartLink™ module is mounted external to the spa cabinet, relocating your router, installing an additional access point or WiFi range extender in closer proximity to the spa.

### Know your SSID Name and Router password

Before beginning the SmartLink™ App setup process you must be aware of your WiFi router's SSID (network name) and password. Failure to have these login credentials on hand whilst you are beside the spa completing the setup process may lead to a failed setup. The login credentials may be labeled on the WiFi router and/or on a card your ISP supplied at time of installation.

Please bring the ISP card with you or write them here for reference:

Router SSID name: .....

Router password: .....

**NOTE:** *Your router password is case sensitive and must be entered 100% correct during the setup process for a successful installation. The SmartLink™ module CANNOT interrogate your password to ensure it is correct. It relies on you entering it correctly. If the password is entered incorrectly you will have to complete the setup process again.*

# WiFi Internet Access

## SSID Name and Router Password

---

### **SPECIAL PASSWORD NOTE FOR V2 MODULES**

*The V2 module CANNOT support the use of a % character, or space in your router password. If your router's password contains a % or space, you either need to change your password, or setup a guest network within your router setup and assign a password that does not contain % or spaces for that guest network. If you fail to do this, the app setup process will complete but your spa will never come online and always report offline.*

### **WiFi signal strength**

WiFi signal strength is extremely important for reliable communication between the SmartLink™ WiFi module and your router. A strong WiFi signal to the SmartLink™ will result in the app being stable, respond faster and the spa will remain online. A weak WiFi signal can cause the app to respond slowly, timeout or cause the spa to drop off line. During the setup process the app will display a list of wireless network SSIDs discovered in proximity to the spa. The signal strength of each network is detailed on the right-hand side in decibels (-dB). The closer the value is to 0, the stronger the signal. This means that -64dB is a stronger signal than -70dB.

A value of -70dB or better is required for reliable operation of V2 modules. A value of -80dB or better is required for reliable operation of V3 modules.

\*Information is subject to change without notice.

# WiFi Signal Strength



**NOTE:** *During the setup process you can use the refresh arrow in the top right corner to perform another WiFi scan and update the dB signal readings (refer picture above). This can be helpful if you are trying to determine the best position for mounting your SmartLink™ module or router.*

# Indicator LEDs V2 & V3 Modules

## V2 Module

The indicator LEDs on the SmartLink module help determine the connection status, mode or activity the module is experiencing. Three indicator LEDs are provided. There are differences between the indicator LED operation between V2 and V3 modules. Please refer to following page careful for definition of indicator LEDs on each respective model.

### V2 Modules

#### Associated (Red LED)

**Flashing** – No WiFi connection

**Off** – connected to WiFi network/router

#### Data Transfer (Blue LED)

**On or Flashing** – Data is being transferred

#### Connection Status (Green LED)

**On Solid** – TCP connection live, spa online

**Fast Flash** – No IP address assigned or module in command mode

**Slow Flash** – WiFi connected but no TCP connection



\*Information is subject to change without notice.



# Indicator LEDs V2 & V3 Modules

## V3 Module

### V3 Modules



#### Associated (Red LED)

**On** – Module is receiving 12V power

**Off** – Data cable disconnected or no 12V power

#### Data Transfer (Blue LED)

**On or Flashing** – data is being transferred

#### Connection Status (Green, Purple, Blue or Yellow LED)

**Green** – No WiFi connection

**Purple** – WiFi connected but no TCP connection

**Blue** – TCP connection live, spa online

**Yellow** – in command/programming mode

# Install the SpaNET™ SmartLink™ App

The SmartLink™ App is available for both Apple® or Android™ devices. Open App Store or Google Play and search, “SpaNET Smartlink” or use the QR codes below.

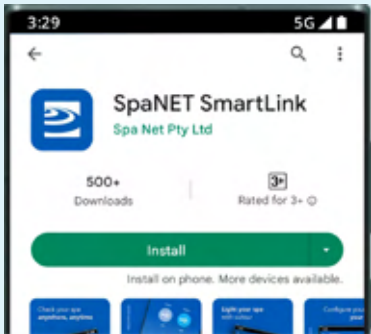

\*Information is subject to change without notice.

# Register an User Account

With the SmartLink™ App now installed you need to register a user account on the SpaNET™ cloud servers which provides a secure and encrypted login to access your spa. Your user account can support multiple SV controllers being configured on the one account in case you own a dual-zone swim spa, or more than one spa at the same or different locations.

A registered account also allows other family members to download the app, login to your registered account, and access the spa on their respective devices.



***You only ever need to register ONE user account once, even if you wish to operate the app across multiple smart devices, concurrently or individually. Complete the user account registration on your first device and take note of the username and password you select during the registration process. On other devices, simply download and install the app and then enter the username and password you have already registered to login to the app. DO NOT complete multiple registrations on each new device. A spa can only be linked to one user account.***

# Sign in with Apple ID or Google Account

---

## REGISTERED EMAIL ADDRESS MUST BE VERIFIED BEFORE SIGN IN

Be sure to check your email after registration and click on the Verify Email link before signing in.

The SmartLink™ app provides the convenience of signing in with either an Apple® or Google® account however there is a limitation if you choose to do this: A spa can only be linked to one Apple® or Google® account.

So, if the app is only to be used on one or more devices using the same Apple/Google account, you can use the respective sign in buttons aside.

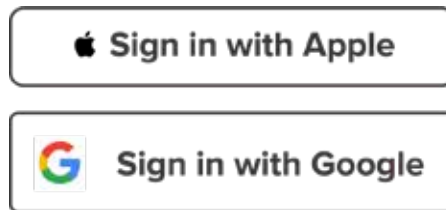

**NOTE:** *If multiple family members wish to access the spa from their own devices using a different Apple® or Google® account this sign in option should NOT be used. This sign in is only suitable for single users.*

\*Information is subject to change without notice.

# SmartLink™ App Setup

## V3 Module App Setup

With the user account now registered, you need to configure the Internet access to your spa in the same way you would connect a laptop or TV to your WiFi router. The setup process is a one-time event that programs the SmartLink™ WiFi module with your router's login credentials (SSID and password) for Internet access and links the spa to your user account on the SmartLink™ Servers.

Unless your router login credentials change, you won't need to run the setup process again. To complete the setup process, ensure that:

- Your smart device is connected to a local WiFi network or is using 4G/5G cellular data.
- **You have the login credentials for your router (WiFi network password) at hand.**
- You are standing within close proximity (1-2m) of the spa.

### Apple® iOS Devices

**Step 1:** Sign-in to app and press on the + button to add a new spa to the user account you are signed in to.

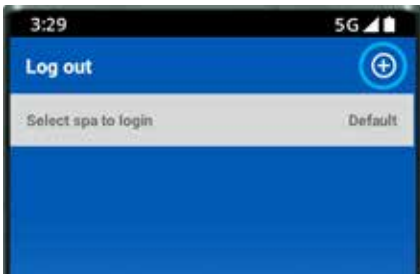

**NOTE:** *A spa can only be setup and accessed on one user account, however multiple spas can be added to the same user account.*

# SmartLink™ Set up Process

## V3 Module App Setup

**Step 2:** Ensure you know your WiFi password or have it with you and press Begin.



**Step 3:** Press on the SmartLink™ V3 module picture to begin setup.



**Step 4: (Apple)** Bluetooth is required for module setup, allow access.



**Step 4: (Android)** Bluetooth is required for module setup, Accept Location Disclosure and then enable Precise location access, while using the app.



\*Information is subject to change without notice.

# SmartLink™ Set up Process

## V3 Module App Setup

**Step 5:** Select SV-Wifi-V3.1 module to start scanning for local WiFi networks.



**Step 7:** Select WiFi network to connect to.



**NOTE:** If no WiFi network found, relocate module to a better position and use the refresh button to conduct a new WiFi scan to see if signal has improved. Signal strengths closer to 0 are stronger. If problems are experienced go Back and re-start process.

**Step 8:** Enter WiFi password, press the eye icon to check it is correct before saving.



**NOTE:** Take care when entering password, the SmartLink™ module or app cannot check or verify the password. It relies on correct entry. If the password is incorrect, you must delete the spa instance and start the setup process again.

**Step 9:** Enter a name for your spa pool, then press Continue, then press Finish.



# SmartLink™ Set up Process

## V3 Module App Setup

Now setup is complete you will be returned to the spa list page, where the spa instance will be displayed as Offline.



Assuming your WiFi network signal was reasonable, and password entered correctly, after a short period the spa will show online.



*If you only have one spa, or if you wish the app to automatically open to the dashboard page of a particular spa (where multiple spas are listed on the one account) rather than opening to this spa list page each time, enable the default slider. A user can always return from the app dashboard page to the spa list page by using the Back arrow in the top left corner of the screen.*

\*Information is subject to change without notice.



# SmartLink™ Set up Process

## V2 Module App Setup

### Apple® iOS Devices

**Step 1:** Sign-in to app and press on the + button to add a new spa to the user account you are signed in to.

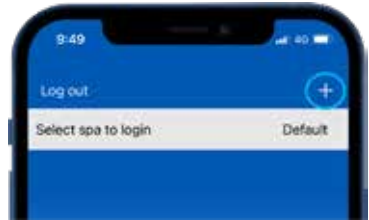

**NOTE:** *A spa can only be setup and accessed on one user account, however multiple spas can be added to the same user account.*

**Step 2:** Ensure you know your WiFi password or have it with you and press Begin.



**Step 3:** Press on the SmartLink V1 or V2 module picture to begin setup.



# SmartLink™ Set up Process

## V2 Modules App Setup

**Step 4:** You are prompted to use the spa keypad to put the SmartLink V2 module into HOT (programming) mode.

**Learn More:** Provides instructions on how to use the spa keypad to enable HOT mode. Carry out those instructions.

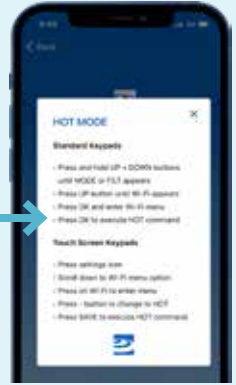

**Step 5:** Once you have executed the HOT command via the spa keypad and display has returned to temp reading press Next.

**Step 6:** You are prompted to connect to the SV WiFi network. Press or slide your Apple® Home button and navigate/switch to your Apple® WiFi settings. **Do NOT** press Next.



\*Information is subject to change without notice.

# SmartLink™ Set up Process

## V2 Modules App Setup

**Step 7:** Within your WiFi settings locate and connect to the SVx-xxxxxxx or SVMx-xxxxxxx network and wait for a short period.



**Step 8:** Once connected to the SVx-xxxxxxx network and “No Internet Connection” appears, press or slide the Apple® Home button to switch back to the SmartLink app.



**Step 9:** Press Next to start scanning for nearby WiFi networks. Wait for scan to complete before pressing anything else.



**Step 9a:** If this is the first time you have run the setup process for a V2 module you will need to Allow permission for a WiFi scan.



**NOTE:** The granting of this permission will often interfere with the initial WiFi scan causing an error. If this occurs press the refresh button to conduct a new WiFi scan.

\*Information is subject to change without notice.

# SmartLink™ Set up Process

## V2 Module App Setup

Step 10: Select WiFi network to connect to.



Step 11: iOS Smart network switching will attempt to drop the SV network which interrupts the setup. You MUST select "Keep Trying Wi-Fi"



**NOTE:** If no WiFi network found, relocate SmartLink module to a better position and use the refresh button to conduct a new WiFi scan to see if signal has improved. Signal strengths closer to 0 are stronger.

*V2 modules require a minimum signal strength of -70dB for reliable operation.*

Step 12: Enter WiFi password, press the eye icon to check it is correct before saving.



**NOTE:** Take care when entering password, the SmartLink module or app cannot check or verify the password.

*If password is incorrect, you must delete the spa and start the setup process again.*

*V2 modules DO NOT support the % character or spaces in the password. If your network password includes either character, you must change it or setup a guest network with a different password.*

\*Information is subject to change without notice.

# SmartLink™ Set up Process

## V2 Module App Setup

**Step 13:** You are prompted to reconnect to your home WiFi network. Press or slide your Apple® Home button and navigate/switch to Apple® WiFi settings. Do NOT press Next.



**Step 14:** Within your WiFi settings ensure your phone has reconnected to your home WiFi network. If this has not occurred automatically, manually select it.



**Step 15:** Once reconnected to your home WiFi network, press or slide the Apple® Home button to switch back to the SmartLink app.



**Step 16:** Press Next to proceed to the final step of naming your spa.



# SmartLink™ Set up Process

## V2 Module App Setup

**Step 17:** Enter name for your spa then press Continue, then Finish to complete setup.

Now setup is complete you will be returned to the spa list page, where the spa instance will be displayed as offline.



Assuming your WiFi network signal was reasonable, and password entered correctly, after a short period the spa will show online.



*If you only have one spa, or if you wish the app to automatically open to the dashboard page of a particular spa (where multiple spas are listed on the one account) rather than opening to this spa list page each time, enable the default slider. A user can always return from the app dashboard page to the spa list page by using the Back arrow in the top left corner of the screen.*

\*Information is subject to change without notice.

# SmartLink™ Set up Process

## Smart Network Switch Warning

### Android™ Devices

Whilst most Android devices will complete the following V2 module app setup process without any problems or settings changes required, we have encountered certain models of the following manufacturers phones that can sometimes freeze or crash during the app setup process:

- Google Pixel devices
- Certain Samsung models (particularly A or Z Series)
- Some Oppo models

The problems arise from often hidden Smart network switching or Intelligent Wi-Fi functions within the Android™ platform that choose to disconnect from a deemed weak WiFi connection and automatically switch to an alternative nearby WiFi network or 4G/5G mobile data. If these smart features remain enabled, during certain parts of the setup process the phone will deem the V2 SmartLink network weak, the connection will be dropped, causing the app to crash or hang.

To overcome this, we recommend that all Android™ users search their WiFi Advanced preferences and disable any Smart Switch feature. These features can be re-enabled after the SmartLink app setup process is complete, as they only affect the initial app setup process on V2 modules.

#### How to disable on Google Pixel

Navigate to WiFi Settings > WiFi Preferences > Advanced  
Disable **Switch to mobile data**

#### How to disable on Samsung devices

Navigate to WiFi Settings > Advanced or Intelligent Wi-Fi  
Disable **Switch to mobile data**  
Disable **Switch to better Wi-Fi networks**

#### How to disable on Oppo devices

Navigate to WiFi Settings > Advanced Settings > Wi-Fi Assistant  
Disable **Auto connect to best Wi-Fi**, **disable Auto switch to mobile network**



# SmartLink™ Set up Process

## V2 Module App Setup

### Android™ Devices

**Step 1:** Sign-in to app and press on the + button to add a new spa to the user account you are signed in to.

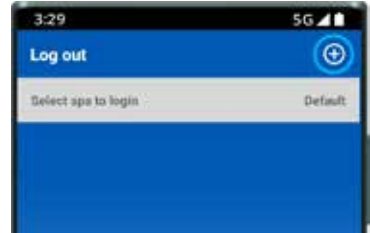

**NOTE:** *A spa can only be setup and accessed on one user account, however multiple spas can be added to the same user account.*

**Step 2:** Ensure you know your WiFi password or have it with you and press Begin.



**Step 3:** Press on the SmartLink V1 or V2 module picture to begin setup.



\*Information is subject to change without notice.



# SmartLink™ Set up Process

## V2 Module App Setup

**Step 4:** You are prompted to use the spa keypad to put the SmartLink V2 module into HOT (programming) mode.

**Learn More:** Provides instructions on how to use the spa keypad to enable HOT mode. Carry out those instructions.



**Step 5:** Once you have executed the HOT command via the spa keypad and display has returned to temp reading press Next.

**Step 6:** You are prompted to connect to the SV WiFi network. Press Next to launch directly into your Android™ WiFi settings.



\*Information is subject to change without notice.

# SmartLink™ Set up Process

## V2 Module App Setup

**Step 7:** Within your WiFi settings locate and select the SVx-xxxxxxx or SVMx-xxxxxxx network and **wait for a short period.**



**Step 7a:** On the first time connecting to the SVx-xxxxxxx network you will receive a no Internet connection warning. **You MUST select: Always Connect / Stay Connected / Keep Wi-Fi Connection.**

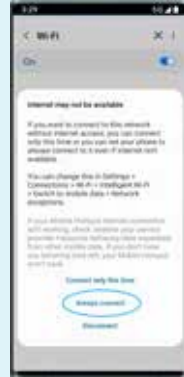

**Step 8:** Once connected to the SVx-xxxxxx network and “Connected without Internet” is displayed, press the Android Back button to return to the SmartLink app



**Step 9:** You are prompted to connect to the SV WiFi network. Press **Next** to launch directly into your Android™ WiFi settings.

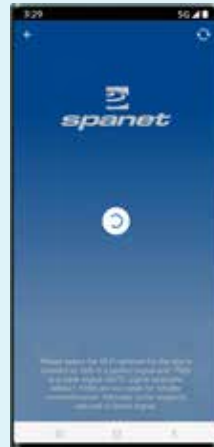

\*Information is subject to change without notice.

# SmartLink™ Set up Process

## V2 Module App Setup

**Step 10:** Select WiFi network to connect to.



**NOTE:** *If no WiFi network found, relocate SmartLink module to a better position and use the refresh button to conduct a new WiFi scan to see if signal has improved. Signal strengths closer to 0 are stronger.*

*V2 modules require a minimum signal strength of -70dB for reliable operation.*

### **SPECIAL PASSWORD NOTE FOR V2 MODULES ONLY**

*The V2 module CANNOT support the use of a % character, or space in your router password. If your router's password contains a % or space, you either need to change your password, or setup a guest network within your router setup and assign a password that does not contain % or spaces for that guest network. If you fail to do this, the app setup process will complete but your spa will never come online and always report offline.*

**Step 11:** Enter WiFi password, press the eye icon to check it is correct before saving.



**NOTE:** *Take care when entering password, the SmartLink module or app cannot check or verify the password. If password is incorrect, you must delete the spa and start the setup process again.*

**Step 12:** You are prompted to reconnect to your home WiFi network. Press **Next** to launch directly into the Android™ WiFi settings.



# SmartLink™ Set up Process

## V2 Module App Setup

**Step 13:** Within your WiFi settings ensure your phone has reconnected to your home WiFi network. If this has not occurred automatically, manually select it.



**Step 14:** Once reconnected to your home WiFi network, press the Android Back button to return to the SmartLink app.



**Step 15:** Enter name for your spa then press Continue, then Finish to complete setup.



Now setup is complete you will be returned to the spa list page, where the spa instance will be displayed as offline.



\*Information is subject to change without notice.

# SmartLink™ Set up Process

## V2 Module App Setup

Assuming your WiFi network signal was reasonable, and password entered correctly, after a few minutes the spa will show online.

Enable default spa slider to auto launch to spa dashboard and skip this page each time the app is opened.



**NOTE:** *If you only have one spa, or if you wish the app to automatically open to the dashboard page of a particular spa (where multiple spas are listed on the one account) rather than opening to this spa list page each time, enable the default slider. A user can always return from the app dashboard page to the spa list page by using the Back arrow in the top left corner of the screen.*

# MySpaPool Voice Control

## Link spa to Google® Assistant

The MySpaPool vocal skill allows you to control any spa pool fitted with our SmartLink module by voice commands. Available on both Google® Assistant and Amazon® Alexa platforms, you can now talk to your spa to activate accessories and alter settings or ask it questions about active modes, settings and status. It really is as simple as talking to your spa.

### Step 1: Link your Google® account to SmartLink App

Open the app, tap the Settings icon, scroll to bottom of settings list and tap the Google® Assistant option. Then select your Google Account to link.

**Important:** *If you have multiple accounts, make sure to select the account that is linked to your Google® Home device(s).*

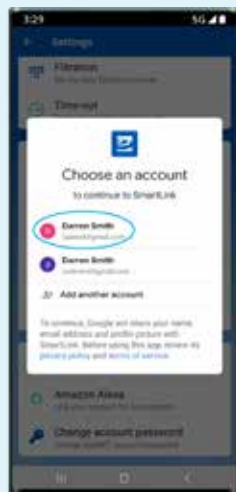
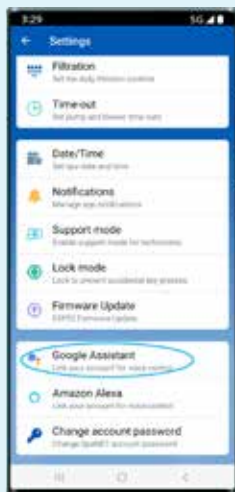

\*Information is subject to change without notice.

# MySpaPool Voice Control

## Link spa to Google® Assistant

### Step 2: Set Google® Assistant PIN within SmartLink App

To meet new Google® security requirements, you must set a pin number for the Google® Assistant voice action to work. From within the SmartLink app Setting list once again tap on the Google® Assistant option and set a four digit pin.

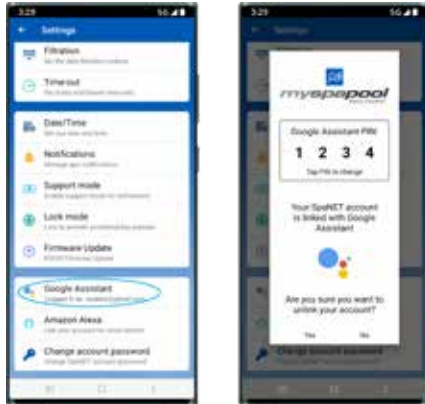

### Step 3: Link Google® Assistant to the MySpaPool action

You may start by saying “Hey Google, talk to my spa pool”. A prompt will appear asking your permission to set up MySpaPool using your Google® account details. Answer ‘Yes’ to this and Terms of Service to successfully complete the account linking step.



\*Information is subject to change without notice.

# MySpaPool Voice Control

## Link spa to Google® Assistant

---

### Step 4: Link your spa to MySpaPool action

Once the account has been linked, the final step is to choose which spa to issue commands to Say, “List my spa”, and Google will then list the name(s) of any spa setup on your SmartLink app. Please select the spa number and not the spa name for Google to recognise your preference.



*Note: On most installs, you will say "1".*

**Change Spas:** *In the case of owning multiple spas or dual-zone swim spas, if you want to change the spa the voice control links to, simply issue the "Hey Google... ask my spa pool... list my spa" command again and select a different spa number.*

\*Information is subject to change without notice.



# Link Spa to Amazon Alexa™

## Voice Control

Linking your spa to Alexa™ is fairly straight forward. To help you do this follow the steps below.

**Note:** *The following setup steps assume you already have a registered Amazon account and have the Amazon Alexa app downloaded and installed on your smart phone.*

### Step 1: Link your Amazon® Alexa™ account to SmartLink app

Open the app, tap the Settings icon, scroll to bottom of settings list and tap the Amazon Alexa option. A prompt will appear asking permission to Sign-In to your Amazon account. To confirm your acceptance and complete the linking process, enter your login details and tap "Sign-In"

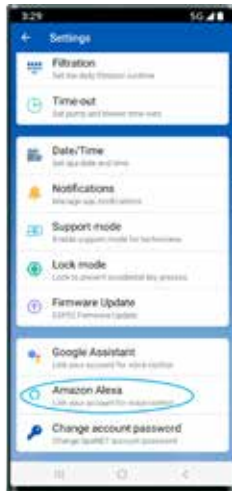

# Link Spa to Amazon Alexa™

## Voice Control

### Step 2: Search the MySpaPool skill

Open the Amazon Alexa app using your smart phone, then using the menu bar of the app, navigate to Skills & Games, then in the search bar type **“my spa pool”** then tap on it to select.

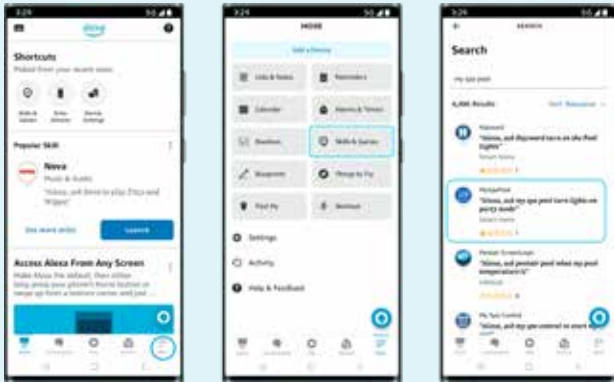

### Step 3: Link your Amazon® Alexa™ app to MySpaPool skill

To complete the My Spa Pool skill linking to your Alexa account and devices simply tap on **“Launch”** or **“Enable to use”** (depending on device). A prompt will appear to complete the link, simply tap on **“Allow”**. Now that you’ve successfully linked the two, the final step is to link your spa to the My Spa Pool voice control skill.

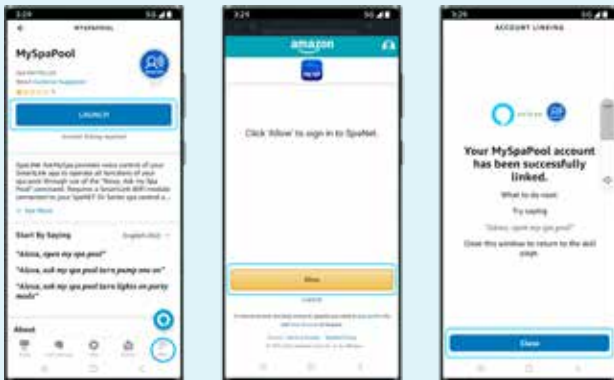

\*Information is subject to change without notice.

# Link Spa to Amazon Alexa™

## Voice Control

---

### Step 4: Link your spa to MySpaPool skill

Once the account has been linked, the final step is to choose which spa to issue commands to. Using either the Amazon Alexa app or an Alexa device, start by saying, “**Hey Alexa... ask my spa pool... list my spa**”. and Alexa will then list the name(s) of any spa setup on your SmartLink app. Please select the spa number and not the spa name for Alexa to recognise your preference.

**Note:** *On most installs, you will say “1”.*

Now the setup is complete, you can start giving vocal commands to your spa. For example, you can say, “**Hey Alexa... ask my spa pool... turn pumps on**”

**Change Spas:** *In the case of owning multiple spas or dual-zone swim spas, if you want to change the spa the voice control links to, simply issue the “**Hey Alexa... ask my spa pool... list my spa**” command again and select a different spa number.*

# Optional Upgrade

## Swim Pole

---

The swim pole is an optional upgrade available on select models.

The swim pole allows the user to swim or jog against tension while in the water resulting in a low-impact workout.



Pole Socket

### Included in your Kit:

- Waist Strap
- Tether
- Pole
- Pole Socket

\*Information is subject to change without notice.

# Legal Information

---

The Bluetooth word mark and logos are registered trademarks owned by Bluetooth SIG, Inc. and any use of such marks by Spa Net Pty Ltd is under license. Other trademarks and trade names are those of their respective owners.

Apple and App Store are trademarks of Apple Inc., registered in the U.S. and other countries.

Android and Google Playware trademarks of Google Inc.

Contains Transmitter Module FCC ID: T9J-RNS2

Contains Transmitter Module FCC ID: T9J-RN131,171

This device complies with Part 15 of the FCC Rules. Operation is subject to the following two conditions: (1) this device may not cause harmful interference, and (2) this device must accept any interference received, including interference that may cause undesired operation.

This equipment has been tested and found to comply with the limits for a Class B digital device, pursuant to part 15 of the FCC Rules. These limits are designed to provide reasonable protection against harmful interference in a residential installation. This equipment generates, uses and can radiate radio frequency energy, and if not installed and used in accordance with the instructions, may cause harmful interference to radio communications. However, there is no guarantee that interference will not occur in a particular installation. If this equipment does cause harmful interference to radio or television reception, which can be determined by turning the equipment off and on, the user is encouraged to try to correct the interference by one or more of the following measures:

- Reorient or relocate the receiving antenna.
- Increase the separation between the equipment and receiver.
- Connect the equipment into an outlet on a circuit different from that to which the receiver is connected.
- Consult the dealer or an experienced radio/TV technician for help.

To satisfy FCC RF Exposure requirements for mobile and base station transmission devices, a separation distance of 20 cm or more should be maintained between the antenna of this device and persons during operation. To ensure compliance, operation at closer than this distance is not recommended. The antenna(s) used for this transmitter must not be co-located or operating in conjunction with any other antenna or transmitter.

# Notes

---

**Model name:** \_\_\_\_\_

**Serial number:** \_\_\_\_\_

**Delivery date:** \_\_\_\_\_

**Sales order number:** \_\_\_\_\_

**Sales person details:** \_\_\_\_\_

**Dealer information:** \_\_\_\_\_

\*Information is subject to change without notice.

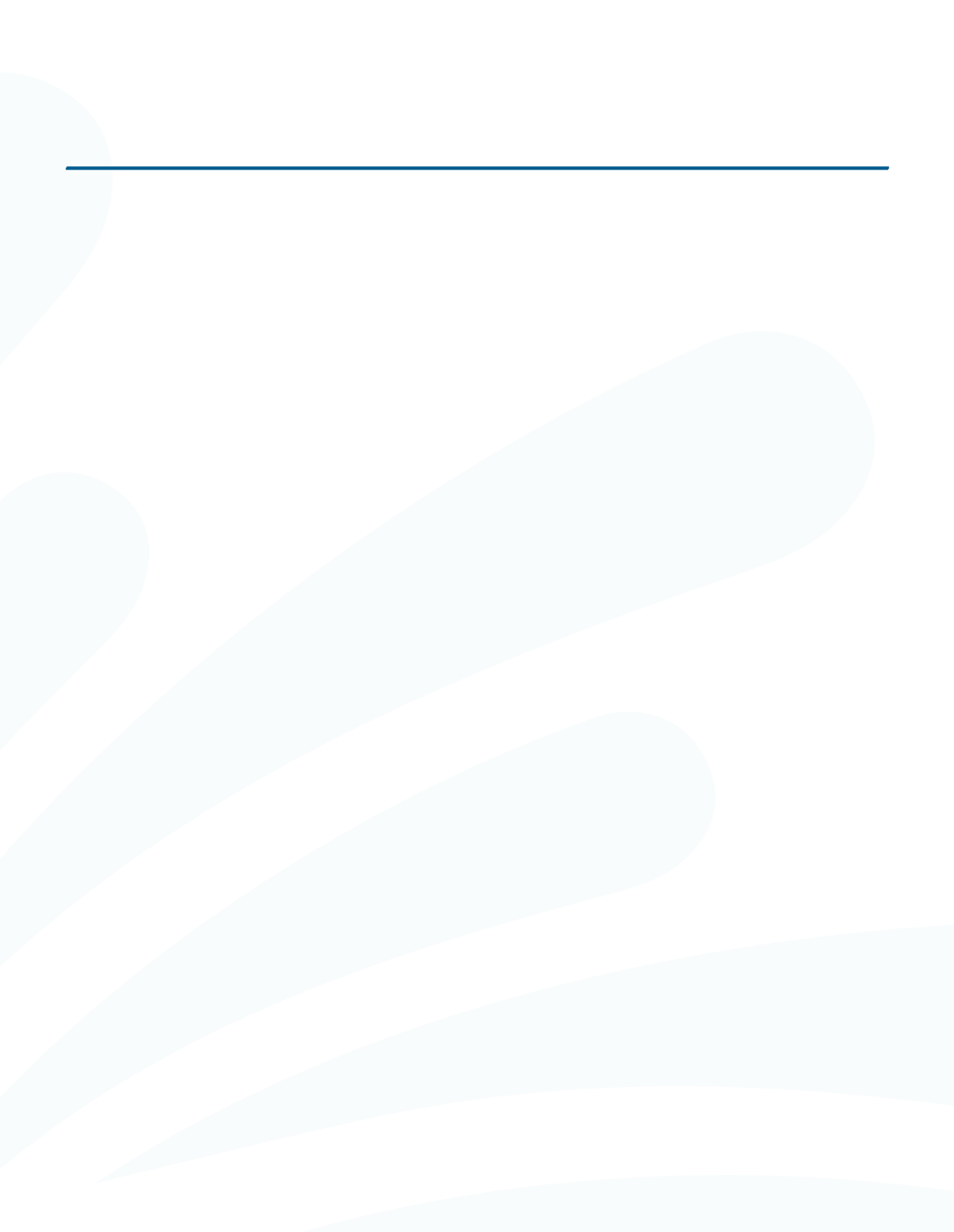

\*Information is subject to change without notice.

# Sun & Soul Spas™

## Limited Warranty

---

### **Vortex Leisure Pty Ltd owns the Sun & Soul Spas brand**

#### **Lifetime Warranty on Permaframe™ Frames**

Vortex Leisure Pty Ltd warrants the structural integrity of the spa frame against defects in workmanship and materials for the lifetime of the spa subject to the limitations, conditions and exclusions expressed in this warranty.

#### **10 year non pro rata structural warranty**

Vortex Leisure Pty Ltd warrants the structure of the spa shell against defects in workmanship and materials leading to water loss from the spa for a period of 10 years from date of manufacture subject to the limitations and conditions expressed in this warranty.

#### **5 year acrylic warranty**

Vortex Leisure Pty Ltd warrants against the loss of water through the acrylic surface of the spa shell for a period of 5 years from date of manufacture, subject to limitations and conditions in this warranty.

#### **5 year jet warranty**

Vortex Leisure Pty Ltd warrants the removable spa jets to be free of manufacturing defects for a period of 5 years from date of manufacture. This warranty excludes damage by grit, sand and improper water chemistry causing corrosion of the part and is limited to supply of replacement parts after the faulty part has been returned to Vortex Leisure Pty Ltd for warranty inspection. Leaking from jets is covered by the plumbing warranty. Laminar jets have a 1 year parts only warranty.

#### **5 year heater warranty**

Vortex Leisure Pty Ltd warrants the heater element against defects in materials and workmanship for a period of 5 years from date of manufacture. After 1 year this warranty is limited to the supply of replacement parts and excludes labour and freight costs. This warranty does not cover damage to heaters caused by incorrect water balance resulting in the heater being subjected to abrasive/acid water.

\*Information is subject to change without notice.



# Sun & Soul Spas™

## Limited Warranty

---

### **5 year plumbing warranty**

Vortex Leisure Pty Ltd warrants the plumbing piping and plumbing joints against defects in materials and workmanship causing leaking for a period of 5 years from date of manufacture. After 1 year this warranty is limited to the supply of replacement parts and excludes all labor and freight costs.

### **2 year pump warranty**

Vortex Leisure Pty Ltd warrants the water pumps against defects in materials and workmanship for a period of 2 years from date of manufacture. After 1 year this warranty is limited to the supply of replacement parts and excludes all labour and freight costs. Damage to the pump motor caused by incorrect chemical balance will not be covered under this warranty. Vortex Leisure Pty Ltd reserves the right to request that the pump be returned for assessment before it is replaced under this warranty.

### **2 year electronic components warranty**

Vortex Leisure Pty Ltd warrants electronic control systems against defects in materials and workmanship for a period of 2 years from date of manufacture. After 1 year the warranty is limited to the supply of replacement parts after the product has been assessed by either Vortex Leisure Pty Ltd or the relevant control system manufacturer.

### **1 year air blower warranty**

Vortex Leisure Pty Ltd warrants the air blower against defects in materials and workmanship for a period of 1 year. This warranty will become void if the blower damage is caused by overfilling.

### **1 year thermoclad cabinet warranty**

Vortex Leisure Pty Ltd warrants the thermoclad spa cabinet against defects in materials and workmanship for a period of 1 year from date of manufacture. This warranty specifically covers the structural integrity of the cabinet. The thermoclad cabinet finish is warranted to be free from defects in materials and workmanship at the time of initial delivery. Fading and weathering of the surface will occur naturally over time, and are not considered defects.

# Sun & Soul Spas™

## Limited Warranty

---

### **1 year Wifi, audio system, ozone, UV, LED light(s) warranty**

Vortex Leisure Pty Ltd warrants the factory installed Wifi, audio system, UV sanitiser, Ozone sanitiser and LED Light(s) assemblies, to be free from defects in materials and workmanship for 1 year. The UV globe is a parts only warranty, if it fails within the 1 year period, a replacement globe will be sent out free of charge to be installed by the customer.

### **1 year external heat pump warranty**

Vortex Leisure Pty Ltd warrants the External Heat Pump to be free from defects in materials and workmanship for 1 year. Installation is to be carried out by a qualified contractor. Failure to do so will immediately VOID this warranty. Vortex Leisure Pty Ltd reserves the right to request the return of the heat pump for assessment before it is replaced or repaired.

### **1 year spa hardcover warranty**

Your Spa Cover is warranted for a period of 1 Year from the date of delivery. This warranty applies only to the structural integrity of the cover and the vinyl. Damage caused to stitching, straps or locks due to improper use of the cover will not be covered under warranty. Disposal of any cover replaced under warranty will be the owners responsibility.

### **Warranty coverage**

Warranty coverage begins at the delivery date. Vortex Leisure Pty Ltd only extends this warranty to the original purchaser and only if the spa has been purchased through an authorized Vortex Leisure Pty Ltd reseller. Written notice of the defect and proof of purchase must be provided to Vortex Leisure Pty Ltd or it's nominated representative within 14 days of the defect occurring. If the spa is required to be returned to Vortex Leisure Pty Ltd for rectification all freight costs shall be pre paid by the customer. Repair or replacement of any defective product is at the sole discretion of Vortex Leisure Pty Ltd. To action warranty service contact the authorized Vortex Leisure Pty Ltd reseller you purchased from. If you are unable to obtain satisfactory service from your reseller, written notification must be provided to Vortex Leisure Pty Ltd within 14 days of the defect occurring. Vortex Leisure Pty Ltd will pay the travel costs of the service agent for the first 40km from their base. Any further travel charges shall be the responsibility of the spa owner.

\*Information is subject to change without notice.

# Sun & Soul Spas™

## Limited Warranty

---

### Electrical connection

All electrical connections must be carried out by a qualified electrical contractor. Failure to do so will immediately VOID this warranty. The spa must be connected to a dedicated MAINS electrical supply circuit protected by a compliant earth leakage circuit breaker safety switch. Vortex Leisure Pty Ltd reserves the right to ask for proof that the spa has been installed by a qualified electrician.

### Warranty exclusions

1. Damage resulting from improper water maintenance.
2. Damage from operating the spa above 45°C.
3. Damage caused by clogged filters
4. Damage caused to the spa by improper use of spa cover and excessive exposure to sunlight.
5. Acts of God.
6. Damage caused by not installing spa on sufficient hard level surface.
7. Damage caused by incorrect electrical installation, brownouts, voltage spikes or operating spa out of +/- 10% of voltage range.
8. Warranty is not extended to filter cartridges, head rests, pump seals or drain hoses.
9. Commercial use reduces all warranties to maximum 6 months.
10. Damage caused by relocation of the spa from its original installed location.
11. Damage by termites, borer or other pests.
12. Damage caused by flooding
13. Damage caused by third party carriers.
14. Damage or corrosion to frame caused by un-repaired leaks or improper drainage.

# Sun & Soul Spas™

## Limited Warranty

---





### **Limitations**

This warranty is the only warranty offered by Vortex Leisure Pty Ltd and excludes any other implied or oral undertakings. Except as described above, this warranty does not cover defects or damage due to normal wear and tear, improper installation, alteration without Vortex Leisure Pty Ltd's prior written consent, accident, acts of God, misuse, abuse, commercial or industrial use of an accessory not approved by Vortex Leisure Pty Ltd, failure to follow Sun & Soul Spas'™ Pre-Delivery Instructions or Owner's Manual, or repairs made or attempted by anyone other than an authorized representative of Vortex Leisure Pty Ltd. Vortex Leisure Pty Ltd or its agents will not be liable for any incidental or consequential loss or injury. Vortex Leisure Pty Ltd will not be liable for costs associated with but not limited to building alterations, removal costs, delivery costs or labour costs associated with the replacement of a spa.

**You must check and tighten all barrel unions regularly. Failure to do so may affect your warranty. See your user manual for further information.**

\*Information is subject to change without notice.

# Information on Composition and Disposal of the Packaging

DESCRIPTION	MATERIAL	SYMBOL	DISPOSAL RECOMMENDATION
WOODEN PALLET	WOOD FOR 50	 FOR 50	SEPARATE WASTE COLLECTION
WOODEN CRATE			WOOD
WOODEN PANEL			<i>for the correct disposal of this packaging, check the local provisions with the competent body</i>
CARDBOARD BOX	CORRUGATED CARDBOARD PAP 20	 PAP 20	SEPARATE WASTE COLLECTION
CARDBOARD SHEET			PAPER
			<i>for the correct disposal of this packaging, check the local provisions with the competent body</i>
CARDBOARD "L" SHAPED PROTECTOR	CARDBOARD (DIFFERENT TYPES) PAP 21	 PAP 21	SEPARATE WASTE COLLECTION
			PAPER
			<i>for the correct disposal of this packaging, check the local provisions with the competent body</i>
AVANA PACKING PAPER	PAPER PAP 22	 PAP 22	SEPARATE WASTE COLLECTION
			PAPER
			<i>for the correct disposal of this packaging, check the local provisions with the competent body</i>
PLASTIC "L" SHAPED PROTECTOR	LOW-DENSITY POLYETHYLENE LDPE 4	 LDPE 4	SEPARATE WASTE COLLECTION
BAG			PLASTIC
ENVELOPE			<i>for the correct disposal of this packaging, check the local provisions with the competent body</i>
"BIG AIR BUBBLE" BUBBLE WRAP	HIGH-DENSITY POLYETHYLENE HDPE 2	 HDPE 2	SEPARATE WASTE COLLECTION
			PLASTIC
			<i>for the correct disposal of this packaging, check the local provisions with the competent body</i>
"SMALL AIR BUBBLE" BUBBLE WRAP	POLYETHYLENE PE 7	 PE 7	SEPARATE WASTE COLLECTION
			PLASTIC
			<i>for the correct disposal of this packaging, check the local provisions with the competent body</i>
STRAPS	POLYPROPYLENE PP 5	 PP 5	SEPARATE WASTE COLLECTION
			PLASTIC
			<i>for the correct disposal of this packaging, check the local provisions with the competent body</i>
PLASTIC PIECES various sizes	POLYSTYRENE EPS 6	 EPS 6	SEPARATE WASTE COLLECTION
			PLASTIC
			<i>for the correct disposal of this packaging, check the local provisions with the competent body</i>
PLASTIC SHEETS	POLYURETHANE PUR 7	 PUR 7	SEPARATE WASTE COLLECTION
			PLASTIC
			<i>for the correct disposal of this packaging, check the local provisions with the competent body</i>
AVANA PADDED BUBBLE ENVELOPE	POLYETHYLENE + PAPER PE1+PAP22	 PE1+PAP22	SEPARATE WASTE COLLECTION
			SEPARATE PLASTIC LINING FROM PAPER
			<i>for the correct disposal of this packaging, check the local provisions with the competent body</i>

\*Information is subject to change without notice.



SUN  
& SOUL