



The image shows a white and grey Jacuzzi hot tub on a stone patio. In the background, there is a wooden deck with a sofa and two armchairs, a wooden fence, and a large tree. The scene is set in a rural landscape with mountains in the distance under a clear sky. The Jacuzzi logo is in the top right corner.

*Jacuzzi*

## J-200<sup>TM</sup> Collection

Owner's Manual: Export

[2530-277EL Rev A](#)

J-285<sup>TM</sup>

J-275<sup>TM</sup>

J-245<sup>TM</sup>

J-235<sup>TM</sup>

J-225<sup>TM</sup>

J-215<sup>TM</sup>

# Attention New Spa Owner!

Congratulations on the purchase of your new Jacuzzi® spa! The following is a list of automated functions performed by your spa. These functions are listed below in an attempt to alleviate any operational concerns you may have during the first 24 hours of ownership! Also listed below are important maintenance recommendations you should observe on a regular basis to protect your new investment.

## Automated Operations

**Blow out cycle:** before each filter cycle, pump 2 will activate to clear out the plumbing lines.

**Clean up cycle:** Begins 30 minutes after a pump is turned off or it has timed out. Pump 1 (low speed) and the CLEARRAY unit turn on and run for 30 minutes.

## Maintain Healthy Spa Water

Always maintain your spa's water chemistry within the following parameters:

	With CLEARRAY®	Without CLEARRAY®
pH	7.4-7.6	7.4-7.6
Free Chlorine	no less than 1.0 ppm	3.0-4.0 ppm
Free Bromine	no less than 2.0 ppm	2.0-4.0 ppm
Total Alkalinity	100-150 ppm	100-150 ppm
Calcium Hardness	150-250 ppm	150-250 ppm

**IMPORTANT:** The CLEARRAY® system is factory installed. If the CLEARRAY® system is altered or is not operating efficiently then follow the "without CLEARRAY®" water chemistry parameters as defined by the Pool & Hot Tub Alliance. CLEARRAY® Unit requires an annual bulb replacement to operate properly.

 **TO DECREASE RISK OF INFECTION OR DISEASE!** Always maintain your spas filter as outlined below to ensure healthy spa water. Refer page 41 "Water Quality Maintenance" for additional information.

## Required Filter Maintenance

Your new spa is equipped with an advanced water filtration system that provides unsurpassed water quality! To ensure maximum water quality at all times, you should clean the filter cartridge once a month, or earlier as necessary. See page 36 for detailed filter cartridge cleaning/replacement instructions.

## Required Water Replacement

 **TO DECREASE RISK OF INFECTION OR DISEASE!** You should replace the spa's water every 3 months. The frequency depends on a number of variables including frequency of use, number of users, and attention paid to water quality maintenance. You will know it is time for a change when you cannot control sudsing and/or you can no longer get the normal feel or sparkle to the water, even though the key water balance measurements are all within the proper parameters. See page 41 for additional information.

\*\*\*\*\* Spa operation subject to change without notice \*\*\*\*\*

# Table of Contents

<b>1.0</b>	<b>Important Spa Owner Information.....</b>	<b>1</b>
<b>2.0</b>	<b>FCC Notice .....</b>	<b>1</b>
<b>3.0</b>	<b>Important Safety Instructions for all Spa Owners .....</b>	<b>2</b>
3.1	Entrapment Risk .....	6
3.2	Hyperthermia .....	7
3.3	Important Safety Instructions.....	8
3.4	PRECAUTIONS-Important Chemical Safety .....	8
3.5	PRECAUTIONS FOR USE OF PRODUCTS CONTAINING SODIUM BROMIDE .....	8
<b>4.0</b>	<b>Choosing A Location.....</b>	<b>9</b>
4.1	Outdoor Location .....	10
4.2	Indoor Location.....	10
<b>5.0</b>	<b>General Electrical Safety Instructions .....</b>	<b>11</b>
<b>6.0</b>	<b>Power Requirements.....</b>	<b>12</b>
<b>7.0</b>	<b>Electrical Wiring Instructions .....</b>	<b>13</b>
<b>8.0</b>	<b>Spa Fill Up Procedure .....</b>	<b>17</b>
<b>9.0</b>	<b>Control Functions.....</b>	<b>22</b>
9.1	Control Panel Buttons.....	22
9.2	Control Panel Display Icons.....	22
9.3	General Spa Features and Controls.....	24
<b>10.0</b>	<b>Operating Instructions .....</b>	<b>25</b>
10.1	Setting Water Temperature.....	25
10.2	Activate Jets Pump .....	26
10.3	Multi-Colored LED Light System Operation.....	26
10.4	Adjusting Individual Jet Flow .....	26
10.5	Air Controls.....	27
10.6	Blow-Out Cycle.....	27
10.7	Cleanup Cycle .....	27
10.8	Optional SmartTub® System .....	27
<b>11.0</b>	<b>Menu Features and Programming Instructions .....</b>	<b>29</b>
11.1	Adjusting the Temperature.....	29
11.2	Programming the Mode Setting.....	30
11.3	Adjusting and Setting the Time.....	31
11.4	Invert the display.....	31
11.5	Locking the Spa.....	32
11.6	Hold (Standby).....	32
11.7	Programming the Filtration Cycles.....	33
11.8	Preferences .....	34

<b>12.0</b>	<b>Spa Maintenance</b> .....	<b>36</b>
12.1	<i>Cleaning The Filters</i> .....	36
12.2	<i>Draining and Refilling</i> .....	38
12.3	<i>Pillow Care</i> .....	39
12.4	<i>Cleaning The Spa Interior</i> .....	39
12.5	<i>Cover Care and Maintenance</i> .....	39
12.6	<i>Maintaining The Synthetic Cabinet</i> .....	40
12.7	<i>Winterizing</i> .....	40
12.8	<i>Restarting Your Spa in Cold Weather</i> .....	41
<b>13.0</b>	<b>Water Quality Maintenance</b> .....	<b>41</b>
13.1	<i>pH Control</i> .....	42
13.2	<i>Sanitizing</i> .....	42
13.3	<i>CLEARRAY®</i> .....	43
13.4	<i>CLEARRAY® Lamp Replacement and Quartz Tube Maintenance</i> .....	44
<b>14.0</b>	<b>Error Conditions/Error Messages</b> .....	<b>47</b>
<b>15.0</b>	<b>Troubleshooting Procedures</b> .....	<b>50</b>
15.1	<i>None of the Components Operate (e.g. Pump, Light)</i> .....	50
15.2	<i>Pump Does Not Operate But Light Does</i> .....	50
15.3	<i>Poor Jet Action</i> .....	50
15.4	<i>Water is Too Hot</i> .....	50
15.5	<i>No Heat</i> .....	51
<b>16.0</b>	<b>Circuit Board Diagrams</b> .....	<b>52</b>
16.1	<i>Export 50 Hz 1-Pump Models</i> .....	52
16.2	<i>Jumper wires and Dip Switch Settings for 1-Pump Single Phase</i> .....	53
16.3	<i>Jumper wires and Dip Switch Settings for 1-Pump 2 out of 3-phase</i> .....	54
16.4	<i>Export 50Hz 2-Pump Models</i> .....	55
16.5	<i>Jumper wires and Dip Switch Settings for 2-Pump Single Phase</i> .....	56
16.6	<i>Jumper wires and Dip Switch Settings for 2-Pump 2 out of 3-phase</i> .....	57

## **1.0 Important Spa Owner Information**

Your Jacuzzi J-200 Collection spa is constructed to the highest standards and is capable of providing many years of trouble-free use. However, because heat retentive materials are utilized to insulate the spa for efficient operation, an uncovered spa surface and wall fittings directly exposed to sunlight and high temperatures for an extended period are subject to permanent damage. Damage caused by exposing the spa to this abuse is not covered under warranty. We recommend that you always keep the spa full of water when it is exposed to direct sunlight and that you keep the Jacuzzi premium insulating cover in place at all times when the spa is not in use. Read and carefully follow the requirements for your spa's support base found in Section 4.0 titled, "Choosing A Location" (page 9).

**Jacuzzi constantly strives to offer the finest spas available, therefore modifications and enhancements may be made which affect the specifications, illustrations and/or instructions contained herein.**

## **2.0 FCC Notice**

This equipment has been tested and found to comply with the limits for a Class B Digital Device, pursuant to Part 15 of the FCC Rules. These limits are designed to provide reasonable protection against harmful interference in a residential installation. This equipment generates, uses and can radiate radio frequency energy and, if not installed and used in accordance with the instructions, may cause harmful interference to radio communications. However, there is no guarantee that interference will not occur in a particular installation. If this equipment does cause harmful interference to radio or television reception, which can be determined by turning the equipment off and on, the user is encouraged to try to correct the interference by one or more of the following measures:

1. Rearrange or relocate the receiving antenna.
2. Increase the separation between the equipment and receiver.
3. Connect the equipment into an outlet on a circuit different from the circuit connected.
4. Consult the dealer or an experienced radio/TV technician for help. Changes or modifications not expressly approved by the party responsible for FCC compliance could void the user's authority to operate this equipment.



## J-200 Export

### 3.0 Important Safety Instructions for all Spa Owners

#### READ AND FOLLOW ALL INSTRUCTIONS CAREFULLY!

This spa was manufactured to meet the standards and specifications outlined in the “Virginia Graeme Baker Pool and Spa Safety Act” (VGB Safety Act). When installing and using this spa, basic safety precautions should always be followed, including:



1.  **DANGER: RISK OF SEVERE INJURY OR DROWNING!**
  - Extreme caution must be exercised to prevent unauthorized access by children.
  - To avoid accidents, ensure that children do not use this spa unless supervised at all times. Adult supervision is a critical safety factor in preventing children from drowning.
  - Use the straps and clip tie downs to secure the spa cover when not in use. This will help discourage unsupervised children from entering the spa. Keep the spa cover secure in high-wind conditions.
  - There is no representation that the cover, clip tie-downs, or actual locks will prevent access to the spa.
  
2.  **DANGER: RISK OF SEVERE INJURY OR DROWNING!**
  - Keep hair, loose articles of clothing or hanging jewelry away from suction fittings, rotating jets or other moving components to avoid entrapment that could lead to drowning or severe injury.
  - Never use the spa unless all suction guards, filter, filter lid, or skimmer assembly are installed to prevent body and/or hair entrapment.
  - Never operate or use the spa if the filter, filter lid, or skimmer assembly are broken or any part of the skimmer assembly is missing. Please contact your dealer or nearest service center for service.
  - The suction fittings and suction covers in this spa are sized to match the specific water flow created by the pump(s). If it is necessary to replace the suction fittings, suction covers or pump(s), be sure that the flow rates are compatible and are in compliance with the VGB Safety Act.
  - Never replace a suction fitting or suction cover with one rated less than the flow rate marked on the original suction fitting. Using improper suction fittings or suction covers can create a body or hair suction entrapment hazard that may lead to drowning or severe injury.
  
3.  **DANGER: RISK OF SEVERE INJURY FROM ELECTRIC SHOCK OR DEATH FROM ELECTROCUTION!**
  - Install the spa at least 5 feet (1.5m), from all metal surfaces. As an alternative, a spa may be installed within 5 feet of metal surfaces if each metal surface is permanently connected (bonded) by a minimum No. 8 AWG (8.4 mm<sup>2</sup>) solid copper conductor attached to the wire connector on the grounding lug, inside the equipment compartment on the equipment box.

- A grounding wire connector is provided on this unit to connect a minimum No. 8 AWG (8.4 mm<sup>2</sup>) solid copper conductor between this unit and any metal equipment, metal enclosures of electrical equipment, metal water pipe, or conduit within 5 feet (1.5m) of the unit.
- Never permit any electrical appliance, such as a light, telephone, radio, television, etc. within 5 feet (1.5m) of a spa unless such appliances are built-in by the manufacturer.
- Never bring any electrical appliances into or near the spa.
- Never operate any electrical appliances from inside the spa or when you are wet.
- The electrical supply for this product must include a suitably rated switch or circuit breaker to open all ungrounded supply conductors to comply with Article 422.20 of the National Electrical Code/USA, ANSI/NFPA 70. The disconnecting means must be readily accessible and visible to the spa occupant but installed at least 5 feet (1.5m), from the spa.
- The electrical circuit supplied for the hot tub must include a suitable ground fault circuit interrupter (GFCI) as required by NEC Article 680.42.

4.  **WARNING: RISK OF SEVERE INJURY OR DEATH!**



- Extreme caution must be exercised to prevent diving or jumping into the spa or slipping and falling, which could result in unconsciousness, drowning, or serious injury. Remember that wet surfaces can be very slippery.
- Never stand, walk or sit on the top railing of the spa.





5.  **WARNING: RISK OF HYPERTHERMIA (OVER-HEATING) CAUSING SEVERE INJURY, BURNS, WELTS OR DEATH!**

- Water temperature in excess of 104°F (40°C) may be injurious to your health.
- Refer to Section 3.2 Hyperthermia for specific causes and symptoms of this condition.
- The water in the spa should never exceed 104°F (40°C). Water temperatures between 100°F (38°C) and 104°F (40°C) are considered safe for a healthy adult.
- Lower water temperatures are recommended for young children (children are especially sensitive to hot water) and when spa use may exceed 10 minutes.
- The Consumer Products Safety Commission/USA has stated that the water temperature in a spa should not exceed 104°F (40°C).
- Always test the spa water temperature before entering the spa. The user should measure the water temperature with an accurate thermometer since the tolerance of water temperature-regulating devices may vary as much as +/- 5°F (2°C).

## J-200 Export

6.  **WARNING: RISK OF SEVERE INJURY OR DEATH!**
- Since excessive water temperatures have a high potential for causing fetal damage during the early months of pregnancy, if pregnant or possibly pregnant, consult your physician before using a spa.
  - Pregnant or possibly pregnant women should limit spa water temperatures to 100°F (38°C).
  - Persons suffering from obesity or a medical history of heart disease, low or high blood pressure, circulatory system problems, diabetes, infectious diseases or immune deficiency syndromes should consult a physician before using a spa.
  - If you experience breathing difficulties in association with using or operating your spa, discontinue use and consult your physician.
  - Persons using medication should consult a physician before using a spa since some medication may induce drowsiness, while other medication may affect heart rate, blood pressure, and circulation.
  - Persons suffering from any condition requiring medical treatment, the elderly, or infants should consult with a physician before using a spa.
  - The use of alcohol, drugs, or medication before or during spa use may lead to unconsciousness with the possibility of drowning.
7.  **WARNING: RISK OF SEVERE INJURY OR DEATH!**
- Prolonged immersion in a spa may be injurious to your health.
  - Observe a reasonable time limit when using the spa. Exposures at higher temperatures can cause high body temperature (overheating). Symptoms may include dizziness, nausea, fainting, drowsiness, and reduced awareness. These effects could possibly result in drowning or serious injury.
  - Never use a spa immediately following strenuous exercise. Enter and exit the spa slowly. Wet surfaces can be slippery.
8.  **WARNING: TO DECREASE RISK OF INFECTION OR DISEASE!**
- To reduce the risk of contracting a waterborne illness (e.g. an infection, bacteria or virus) and/or respiratory ailments, maintain water chemistry within the parameters listed on the inside cover of this manual and consult with a licensed engineer regarding proper ventilation if installed indoors or in an enclosed area.
  - People with infectious diseases should not use a spa to avoid water contamination, which could result in spreading infections to others.
  - Always shower before and after using your spa. Maintain water chemistry in accordance with manufacturer's instructions. Failure to do so may result in contracting a waterborne illness (e.g. an infection, bacteria or virus).



9.  **WARNING:** In addition to maintenance of filters and water chemistry, proper ventilation is recommended to reduce the risk of contracting a waterborne illness (e.g. an infection, bacteria or virus) and/or respiratory ailments that could be present in the air or water. Consult a licensed architect or building contractor to determine your specific needs if installing your hot tub indoors.
  
10. **CAUTION: TO DECREASE RISK OF PRODUCT DAMAGE.**
  - Maintain water chemistry in accordance with manufacturer's instructions.
  - Proper chemical maintenance of spa water is necessary to maintain safe water and prevent possible damage to spa components.
  
11.  **WARNING: RISK OF SEVERE INJURY OR DEATH!** The appliance is not intended for use by persons (including children) with reduced physical, sensory or mental capabilities, or lack of experience or knowledge, unless they have been given supervision or instruction concerning use of the appliance by a person responsible for their safety.
  
12. **NOTE:** This spa is not intended nor designed to be used in a commercial or public application. The spa buyer shall determine whether there are any code restrictions on the use or installation of this spa since local code requirements vary from one locality to another.

## **Hot Tub Safety Literature**

To ensure you have a safe and enjoyable hot tub experience, learn all you can about hot tub safety and emergency procedures.

The Pool & Hot Tub Alliance has a great source of safety literature.

- Go to <http://phta.org>
- Conduct your own search on the internet
- Write to the following address:  
Pool & Hot Tub Alliance  
2111 Eisenhower Avenue  
Alexandria VA 22314  
703.838.0083

# J-200 Export

## 3.1 Entrapment Risk



The Consumer Products Safety Commission/USA has reported that users of pools and spas have become entrapped (stuck) to drain and/or suction fittings causing death, drowning, or serious injury (see diagram below). This spa was manufactured to meet the standards and specifications outlined in the "Virginia Graeme Baker Pool and Spa Safety Act" (VGB Safety Act). Entrapment risk can be minimized if proper precautions are taken.



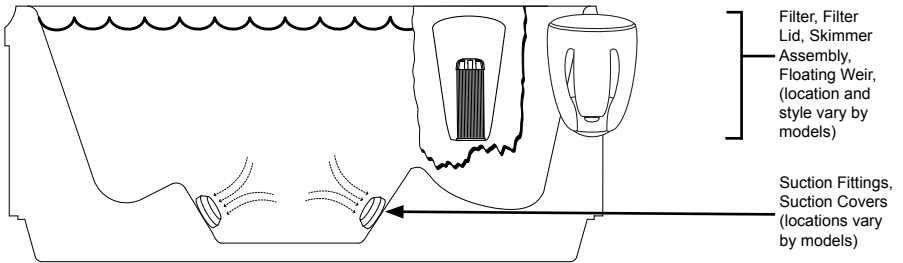

**DANGER: RISK OF PERSONAL INJURY OR DEATH!**  
Never operate the spa if a suction fitting, suction cover, filter, filter lid or skimmer assembly are broken, damaged or missing.



**Note: Suction covers must be replaced every 7 years.**

1.  **DANGER: RISK OF SEVERE INJURY OR DROWNING!**  
**Hair entrapment:** May occur if hair is entangled, knotted or snagged in a drain suction or skimmer assembly. This has been reported in persons who when submerge themselves underwater, allowing hair to come close and/or within the reach of the suction fittings, suction covers or skimmer assembly.
  - Keep hair away from suction fittings, suction covers, filter, filter lid or skimmer assembly.
  - Children are at risk for hair entrapment if swimming under water.
  - Never allow children to play or get near the suction fittings, suction covers, filter, filter lid or skimmer assembly.
  
2.  **DANGER: RISK OF SEVERE INJURY OR DROWNING!**  
**Limb entrapment:** May occur when a limb becomes entrapped, inserted or sucked into a suction or outlet opening.
  - Always keep suction fittings, suction covers, filter, filter lid or skimmer assembly in place when operating to avoid limb entrapment.
  - Never allow children to play or get near the suction fittings, suction covers, filter, filter lid or skimmer assembly.
  
3.  **DANGER: RISK OF SEVERE INJURY OR DROWNING! Body entrapment:**
  - Do not insert fingers in massage jet nozzle.



4.  **DANGER: RISK OF SEVERE INJURY OR DROWNING!**  
**Body entrapment:** May occur when part of the torso becomes entrapped, inserted or sucked into a suction or outlet opening.
  - Never allow children to play or get near the suction fittings, suction covers, filter, filter lid or skimmer assembly.
  
5.  **DANGER: RISK OF SEVERE INJURY OR DROWNING!**  
**Evisceration (disembowelment) entrapment:** May occur when the buttocks becomes entrapped, inserted or sucked into a suction or outlet opening.
  - Never sit on suction fittings, suction covers, filter, filter lid or skimmer assembly.
  - Never allow children to play or get near the suction fittings, suction covers, filter, filter lid or skimmer assembly.
  
6.  **DANGER: RISK OF SEVERE INJURY OR DROWNING!**  
**Mechanical entrapment:** May occur when jewelry, swimsuit, or hair accessories become entangled, knotted or snagged in a drain suction or skimmer assembly.
  - Never allow your jewelry, swimsuit, or hair accessories to come close to the suction fittings, suction covers or skimmer assembly.
  - Never allow children to play or get near the suction fittings, suction covers, filter, filter lid or skimmer assembly.

### 3.2 Hyperthermia

Prolonged immersion in hot water may induce hyperthermia (overheating). The use of alcohol or drugs can greatly increase the risk of fatal hyperthermia in spas. A description of the causes, symptoms, and effects of hyperthermia are as follows.

Hyperthermia occurs when the internal temperature of the body reaches a level several degrees above the normal body temperature of 98.6°F (37°C). The symptoms of hyperthermia include drowsiness, lethargy (fatigue), and an increase in the internal temperature of the body. The effects of hyperthermia include:

- Unawareness of impending hazard;
- Failure to perceive heat;
- Failure to recognize the need to exit spa;
- Physical inability to exit spa;
- Fetal damage in pregnant women; and
- Unconsciousness and DANGER of drowning.

A Warning Sign is provided in your warranty packet. Please install at a location near your spa, where it is visible to users of the spa. For additional or replacement Warning Signs please contact your local Jacuzzi dealer and reference item number #6530-082.

## **J-200 Export**

### **3.3 Important Safety Instructions**

When using this electrical equipment, basic safety precautions should always be followed, including the following:

- 1. READ AND FOLLOW ALL INSTRUCTIONS.**
- A green colored terminal or a terminal marked G, Gr, Ground, Grounding or the  $\oplus$  symbol\* is located inside the supply terminal box or compartment. To reduce the risk of electric shock, this terminal must be connected to the grounding means provided in the electric supply service panel with a continuous copper wire equivalent in size to the circuit conductors that supply this equipment (\*IEC Publication 417, Symbol 5019).
- At least two lugs marked "Bonding Lugs" are provided on the external surface or on the inside of the supply terminal box/ compartment. To reduce the risk of electric shock, connect the local common bonding grid in the area of the spa to these terminals with an insulated or bare copper conductor not smaller than No. 6 AWG (10 mm<sup>2</sup>).
- All field installed metal components such as rails, ladders, drains or other similar hardware within 10 feet (3m) of the spa shall be bonded to the equipment grounding buss with copper conductors not smaller than No. 6 AWG (10 mm<sup>2</sup>).
- 5. SAVE THESE INSTRUCTIONS.**

### **3.4 PRECAUTIONS-Important Chemical Safety**

Do not use this device with bromide products.

### **3.5 PRECAUTIONS FOR USE OF PRODUCTS CONTAINING SODIUM BROMIDE**

- Do not use any Product containing Sodium Bromide with an electrolysis device (for example, a chlorine generator).
- Do not use any Product containing Sodium Bromide with ozonation.
- Do not use any Product containing Sodium Bromide with ultraviolet (UV).

## 4.0 Choosing A Location

**IMPORTANT:** Because of the combined weight of the spa, water and users, it is extremely important that the base upon which the spa rests be smooth, flat, level and capable of uniformly supporting this weight, without shifting or settling, for the entire time the spa is in place. Visit [www.Jacuzzi.com](http://www.Jacuzzi.com) for weight information. If the spa is placed on a surface which does not meet these requirements, damage to the skirt and/or the spa shell may result. Damage caused by improper support is not covered under warranty. It is the responsibility of the spa owner to assure the integrity of the support at all times. We recommend a poured, reinforced concrete slab with a minimum thickness of 4 inches (10 cm). Wood decking is also acceptable provided it is constructed so that it meets the requirements outlined above.



**WARNING:** For spas that are to rest on balconies, roofs or other platforms not specifically tied into main structural support, consult a professional Structural Engineer with experience in this type of application.



**WARNING:** Proper drainage is required. The installation must not allow the spa equipment bay to become flooded or wetted (by external water). It is your responsibility, and the responsibility of any installation contractor you hire, to make sure that all applicable codes and/or local construction requirements are met. If in doubt, refer to the building authority responsible for approving the proposed installation site.

The spa must be installed in such a manner as to provide drainage away from it. Placing the spa in a depression without provisions for proper drainage could allow rain, overflow, leaks from spa plumbing, and other casual water to flood the equipment and create a wet condition in which it would sit in. For spas which will be installed below grade or recessed into a floor or deck, install so as to permit access to the equipment, either from above or below, for servicing. Make certain that there are no obstructions which would prevent removal of all side cabinet side panels and access to the jet components, especially on the side with the equipment bay.



**CAUTION:** If the spa is indoors or located in an enclosed area, proper ventilation should be discussed with an Engineer or authority competent enough to understand the necessary provisions needed to vent moist or heated air and air associated with chemical odors outdoors. **When the spa is in use considerable amounts of moisture will escape potentially causing mold and mildew.** This can cause health risk. Over time, this can damage certain surfaces, surroundings, and equipment.

## J-200 Export

### 4.1 Outdoor Location

In selecting the ideal outdoor location for your spa, we suggest that you take into consideration:

- The proximity to changing area and shelter (especially in colder weather).
- The pathway to and from your spa (this should be free of debris so that dirt and leaves are not easily tracked into the spa).
- The closeness to trees and shrubbery (remember that leaves and birds could create extra work in keeping the spa clean).
- A sheltered environment (less wind and weather exposure can result in lowered operation and maintenance costs).
- The overall enhancement of your environment. It is preferable not to place the spa under an unglutted roof overhang since run-off water will shorten the life expectancy of the spa cover.
- For spas that are to rest on balconies, roofs or other platforms not specifically tied into main structural support, consult a professional Structural Engineer with experience in this type of application.
- In the unlikely event that you should ever need to access or gain entry to any portion of the spa for servicing, it is highly recommended that you plan your outdoor installation to provide full access to the entire spa. Please take this into consideration when placing the spa in a deck or enclosed by a surrounding.
- Consider locating your spa away from any reflective surface or glass to prevent any damage to the synthetic skirt.
- Do not shim the spa. To ensure proper support the spa must sit flat on the intended foundation.

### 4.2 Indoor Location

For indoor installations many factors need to be considered before installing a spa indoors:



**WARNING:** In addition to maintenance of filters and water chemistry, proper ventilation is recommended to reduce the risk of contracting a waterborne illness (e.g. an infection, bacteria or virus) and/or respiratory ailments that could be present in the air or water. Consult a licensed architect or building contractor to determine your specific needs if installing your hot tub indoors.

- **Proper Foundation: Consult a Structural Engineer when considering a foundation that will adequately support the spa the entire time it is in place.** Proper support is critical especially if the spa is to rest on a second story or higher. For spas that are to rest on balconies, roofs or other platforms not specifically tied into the main structural support, you should consult a professional Structural Engineer with experience in this type of application.

- **Proper Drainage: It is extremely important to have in place measures to sufficiently handle excessive water spillage.** Be sure the flooring in which the spa rests on has adequate drainage and can handle the entire contents of the spa. Be sure to make provisions for ceilings and other structures that may be below the spa installation. Areas around your spa can become wet or moist so all flooring and subsequent furniture, walls and adjacent structures should be able to withstand or resist water and moisture.
- **Proper Ventilation: Proper ventilation should be discussed with an Engineer or authority competent enough to understand the necessary provisions needed to vent moist or heated air and air associated with chemical odors outdoors.** When the spa is in use considerable amounts of moisture will escape, potentially causing mold and mildew over time which can damage certain surfaces and/or surroundings.
- **Sufficient Access:** In the unlikely event that you should ever need to access or gain entry to any portion of the spa for servicing, it is highly recommended that you plan your indoor installation to provide full access to the entire spa.
- **Warranty:** Damage caused by not following these guidelines or any improper installation not in accordance to local codes or authorities is not covered under the spas warranty. Please consult your local state or city building ordinances.
- **Do not shim the spa.** To ensure proper support the spa must sit flat on the intended foundation.

### 5.0 General Electrical Safety Instructions

Your new Jacuzzi spa is equipped with a “state-of-the-art” equipment system. It contains the most advanced safety and self-protective equipment in the industry. Nonetheless, this spa must be installed properly to insure dependable usage. Please contact your dealer or local building department should you have any questions regarding your installation.

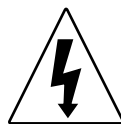

Proper grounding is extremely important. Jacuzzi spas are equipped with a current collector system. A pressure wire connector is provided on the surface of the control box, located outside the equipment door (page 15) to permit connection of a bonding wire between this point and any ground metal equipment, metal water pipe or conduit within 5 feet (1.5m) of the spa, or copper clad grounding rod buried within 5 feet (1.5m) of the spa. Bonding wire must be at least No. 8 AWG (8.4 mm<sup>2</sup>) solid copper wire. This is a most important safety assurance feature. Before installing this spa, check with the local building department to insure installation conforms to local building codes.

## J-200 Export

### 6.0 Power Requirements

Jacuzzi spas are designed to provide optimum performance and flexibility of use when connected to the maximum electrical service listed below. Minor circuit board modifications can be performed to allow your new spa to accept an electrical service other than the factory operation setting. The electrical wiring of this spa must meet the requirements of any applicable state or local codes.

**Note:** Refer to pages 52-55 for circuit board configuration details or contact your authorized Jacuzzi dealer.

#### Export Models (50 Hz) Service

	Single Breaker*	Single Breaker**
Voltage:	230 VAC	230 VAC
<u>Max. Current Draw:</u>		
1-Pump System	17A	21A
2-Pump System	17A	28A
<u>Wattage:</u>		
1-Pump System:	3.9 kW	4.8 kW
2-Pump System:	3.9 kW	6.4 kW
Frequency:	50 Hz	50 Hz
Number of Wires:	3	3

\* For this service, the heater will not operate while any jets pump is running in high speed. You can run pump 1 low speed with the heater. **Note:** ***pump 2 runs only in high speed.***

\*\* For this service, the heater will operate while the jets pumps are running in high speed. This is the maximum current draw. **Note:** ***pump 2 runs only in high speed.***

#### Export Models (50 Hz) Service

	Two of Three Phase
Voltage:	230 VAC
<u>Max. Current Draw:</u>	
1-Pump System	12A/9A
2-Pump System	12A/16A
<u>Wattage:</u>	
1-Pump System:	2.8kW/2.1kW
2-Pump System:	2.8kW/3.7kW
Frequency:	50 Hz
Number of Wires:	4

In this configuration, the heater **will operate** while any jets pump is running in high speed.



## **7.0 Electrical Wiring Instructions**



**IMPORTANT NOTICE:** The electrical wiring of this spa must meet the requirements of any applicable state or local codes. The electrical circuit must be installed by a qualified electrician and approved by a local building/electrical inspection authority.

1. **Dedicated 230V-240V models must be permanently connected (hard-wired) to the power supply.** No plug-in connections or extension cords are to be used in conjunction with the operation of this spa. Supplying power to the spa which is not in accordance with these instructions will void both the independent testing agency listing and the manufacturer's warranty.
2. The power supplied to this spa must be a dedicated circuit with no other appliances or lights sharing the power provided by the circuit.
3. To determine the current, voltage and wire size required, refer to Section 6.0 "Power Requirements" (page 12).
  - Wire size must be appropriate per local codes.
  - The spa controller's terminal block will accept a maximum wire size of 6 AWG (10 mm<sup>2</sup>).
4. The electrical supply for this product must include a suitably rated isolating switch and circuit breaker to comply with local electrical regulations. This RCD/GFCI circuit breaker must be installed at the power supply in the house electrical box.
5. For Australia/ New Zealand, the spa should be supplied through a residual current device (RCD) with a rated tripping current not exceeding 30mA (IEC 60335-2-60).
6. The appliance is not intended for use at altitudes exceeding 2 000 m.
7. To gain access to the spa's power terminal block (Figure 1):
  - Remove the corner panels. Grab the top of the panel and pull forward to unsnap it from the clips. Then lift the panel up to remove.
  - To remove the front panel. Start at one end and pull the panel forward to unsnap it from the retaining clips, at the top. Work your way along the entire length of the panel.
  - Once the panel is unclipped, tilt it slightly forward and lift the panel up to remove. Be careful with the exterior light cord. Disconnect it before fully removing the panel.
  - Remove the insulation panel and place it in a safe location.
8. Select the power supply inlet you want to use (Figure B). Feed power cable to control box, then install it through the large opening provided on the side of the box.
9. Connect wires on terminal block TB1 (Figure B, page 15). **TIGHTEN SECURELY!** All wires must be hooked up securely or damage could result.
10. Re-install control box door and screws, insulation panel (if equipped), secure the insulation blanket (if equipped), and reinstall the cabinet side panels.

**Figure 1**

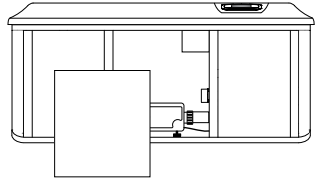
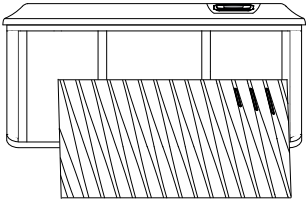
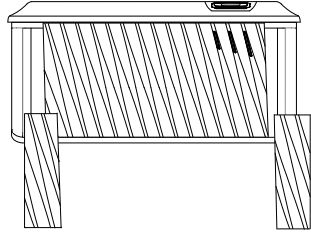
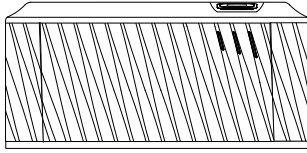

**Figure A  
Equipment Area**

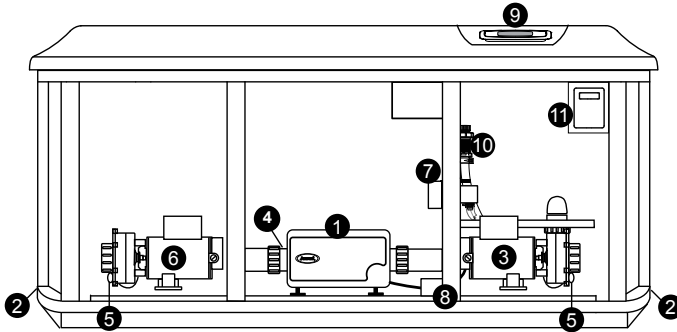

Note: Equipment location (such as pumps, CLEARRAY®, drain, heater etc.) varies by model.

- |                          |   |
|--------------------------|---|
| 1. Control Box           | 7. CLEARRAY® Unit                             |
| 2. Power Supply Inlet(s) | 8. CLEARRAY Water Purification System Ballast |
| 3. 2-Speed Pump          | 9. Control Panel                              |
| 4. Heater                | 10. Spa Drain                                 |
| 5. Pump Drain Plug(s)    | 11. Optional SmartTub® System                 |
| 6. 1-Speed Pump          |   |

**Figure B Control Box**

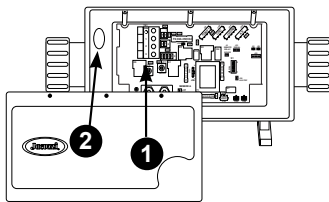

1. Main Terminal
2. Power wires entrance (electrical fitting and conduit must be installed)

**Figure C  
(Export 50 Hz  
230 VAC Connection\*)**



**\*IMPORTANT NOTE:** Wire connections on controller board must be changed depending on the number of breakers being used, pages 52-55.

FOR 2 OR 3 SERVICE SEE WIRE DIAGRAM



WIRE STRIP LENGTH  
11/16" (0.69", 17.5mm)  
BARE METAL



HAND TIGHTEN WITH PHILIPS SCREWDRIVER.

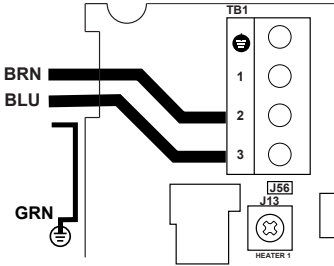

**Factory Default**

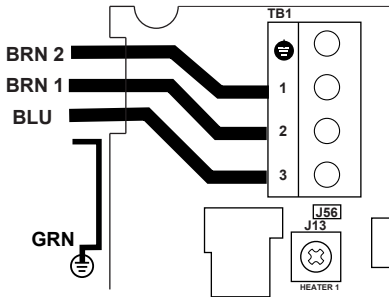

**BRN LINE 3**  **LINE 3 - CAP (INSULATE) END.  
DO NOT CONNECT**

## **8.0 Spa Fill Up Procedure**

For best results, read each step in its entirety before proceeding with that step. Make sure all drains are closed before you begin, page 38.

### **1. Prepare The Spa For Filling**

- Clear all debris from the spa. (Although the spa shell has been polished at the factory, you may want to treat it with a specially formulated spa cleaner.) Consult your authorized Jacuzzi dealer for additional information prior to filling spa.
- If using the primary filter inlet to fill, remove filter cover, then remove filter cartridge as outlined in Section 12.1 (page 36).

**IMPORTANT:** In most cases, filling the spa by placing the hose in the footwell will not create an airlock, page 17. If you experience an airlock we recommend filling by placing the end of your garden hose into the primary filter fitting inlet. This wall fitting is the one with the grid, page 36.

### **2. Fill Spa**

- Place the end of your garden hose into the one of the following primary filter inlet or footwell. Fill until water covers all jets but does not touch the bottom of the lowest headrest.

-  **WARNING: TO DECREASE RISK OF INFECTION OR DISEASE.**

Fill hot tub with clean tap water from garden hose, to reduce risk of contracting a waterborne illness (e.g. an infection, bacteria or virus) and/or respiratory ailments. Fill until water covers all jets but does not touch the bottom of the lowest headrest. (DO NOT OVERFILL!)



**CAUTION: TO DECREASE BUILD UP ON COMPONENTS AND MINIMIZE ACRYLIC DAMAGE.**

Never fill with water from a water softener. If your water is extremely "hard," it is preferable to fill half-way with hard water and the rest of the way with softened water. Water that is too soft can be corrosive to metal components.

### **3. Turn On Power (Priming Mode)**

- Turn on power to spa at the home's circuit breaker to start the priming of the pumps.
- After power is applied, the control panel displays a sequence of configuration settings.
- Then it will display the following: **RUN, PMPS, PURG, AIR, - - - -**. This cycle will last about 4-5 minutes.
- To begin the Priming Mode press the Jets 1 button twice to activate high speed. If you have a two pump system, press the Jets 2 button to turn the pump on.

## J-200 Export

- After the cycle ends, the display briefly shows the set temperature. Then it displays  or . After a minute, the actual water temperature will be displayed. You can manually turn the pumps off after the temperature is displayed.

**Note:** You can skip the Priming Mode by pressing either the Up or Down button. This is not recommended.

### 4. Activate Jets Pumps

Turn on jets pump(s) to ensure proper mixing when adding start-up chemicals in step 5.



### 5. Add Start-Up Chemicals

Add the spa water chemicals as recommended by your authorized Jacuzzi dealer. See Section 13.0 “Water Quality Maintenance” (page 41) for general guidance.



#### **WARNING: RISK OF POISONING OR DEATH.**





Never leave chemicals opened and accessible to anyone. Use chemicals according to the vendors instructions. Always store chemicals in a safe and/or locked location. Keep away from and out of reach of children.

### 6. Establish A Stable Sanitizer Reading

Establish a stable sanitizer reading of no less than 1.0 ppm free chlorine or 2.0 ppm bromine. To ensure healthy water conditions, always maintain a constant sanitizer reading within the levels recommended on the inside cover of this manual.

### 7. Set Spa To Heat

To warm spa water to a comfortable temperature, follow these steps:

- The LCD display on the control panel displays the actual temperature of the spa water. Press either the **COOLER** (  ) or **WARMER** (  ) button once to display the “set” temperature. If you want the water to heat to a different temperature, simply press **COOLER** (  ) or **WARMER** (  ) within 5 seconds. The set temperature increases or decreases by 0.5°C (1°F) each time one of these buttons is pressed.
- The heater will turn off when the temperature corresponding to the thermostat setting is achieved.



**Important Heater Details:**

- The maximum water temperature setting for your spa is 40°C (104°F) and the minimum setting is 18.5°C (65°F).
- For Export spas connected to a 20 amp service, jets pump #1 must be set to low speed and jets pump #2 must be turned off to operate the heater.
- Setting the thermostat at maximum will not accelerate the heating process. This will only result in a higher ultimate temperature.
- The heater operates until the water reaches 0.5°C (1°F) above the programmed “set temperature,” then turns off. The heater will reactivate after the water cools to approximately 0.5°C (1°F) below the “set temperature.”

**8. Place Cover On Spa**

- Keeping the insulating cover in place anytime the spa is not in use will reduce the time required for heating, thereby minimizing operating costs.
- The time required for initial heat-up will vary depending on the starting water temperature.



**DANGER: RISK OF PERSONAL INJURY.**

Check water temperature carefully before entering hot tub! Excessive water temperature can cause burns, welts and body temperature to rise, hyperthermia (over-heating).

**Decontamination Procedure (Steps 9-15)**

Steps 9-15 below are only required when sanitizer levels are unstable after performing steps 1-6 above. Disregard steps 9-15 below if sanitizer levels remain stable after performing steps 1-6 above (refer to the inside cover of the manual).

**Note:** The “decontamination procedure” steps 9-15 should also be used after the spa has been “Winterized” (Section 12.7, page 40) or has been sitting without power for an extended period.

9. Add 2.5 ounces of sodium dichlor for every 100 gallons of water. Refer to the table below for approximate water fill volume by model.



**CAUTION: RISK OF PERSONAL INJURY OR SPA DAMAGE!**

Never add chlorine tablets (trichlor) or acid to your hot tub for any reason! These chemicals may damage components within your hot tub, burn or irritate your skin, create a rash, and void the manufacturer warranty for your spa.

## J-200 Export

### Water Fill Volume by Model

Model	Average Fill Volume*	Sodium Dichlor
J-285	365 Gal (1,382 L)	9.0 oz
J-275	360 Gal (1,363 L)	9.0 oz
J-245	320 Gal (1,211 L)	8.0 oz
J-235	305 Gal (1,155 L)	8.0 oz
J-225	280 Gal (1,060 L)	7.0 oz
J-215	220 Gal (833 L)	5.0 oz

\*Use average fill volume for chemical maintenance

10. Leave spa cover open during this step to allow excessive chemical vapors to exit spa, protecting pillows and plastic knobs from chemical attack. If spa is indoors, open doors and windows for proper ventilation. Turn on all jet pumps for one hour, then open all air controls.

**Note:** You will need to press the jets pump button(s) every 20 minutes since these functions have an automatic 20 minute time-out function that turns them off.



#### **WARNING: RISK OF PERSONAL INJURY!**

- To decrease the risk of injury, drowning or entrapment, never leave your hot tub unattended for any reason while the cover is open and accessible, especially to small children and animals!
- Precautions should be taken to minimize your exposure to chemical vapors (that could cause lung, brain, or skin damage).

11. Turn off power to the spa at the circuit breaker, then drain spa as outlined in Section 12.2 "Draining And Refilling" (page 38).
12. Fill spa until water covers all jets but does not touch the bottom of the lowest headrest. DO NOT OVERFILL.

#### **CAUTION: TO DECREASE BUILD UP ON COMPONENTS AND MINIMIZE ACRYLIC DAMAGE.**

Never fill with water from a water softener. If your water is extremely "hard," it is preferable to fill half-way with hard water and the rest of the way with softened water. Water that is too soft can be corrosive to metal components.



13. Consult your authorized Jacuzzi dealer for chemical recommendations, then add chemicals to hot tub water to achieve a constant sanitizer reading within the levels recommended on the inside cover of this manual.
14. Turn on all jet pumps when adding chemicals to ensure proper mixing and leave your hot tub cover open until the sanitizer level becomes stable to protect pillows and plastic knobs from chemical attack. Refer to the inside cover of the manual.



**WARNING: RISK OF PERSONAL INJURY.**

- To decrease the risk of injury, entrapment or drowning, never leave your hot tub unattended for any reason, especially if while the cover is open and accessible to small children and animals!
- To decrease the risk of contracting a waterborne illness (e.g. an infection, bacteria or virus) and/or respiratory ailments, maintain water chemistry within 6 step parameters. If you or other bathers experience such a condition, discontinue use and seek immediate medical attention.

15. Establish a sanitizer reading no less than 1.0 ppm free chlorine or 2.0 ppm bromine, then allow the hot tub to set undisturbed for 8 hours. Retest water after 8 hours to determine if sanitizer levels are stable. If sanitizer levels are stable, your spa is ready for use. To ensure healthy water conditions, always maintain a constant sanitizer reading within the levels recommended on the inside cover of this manual. If sanitizer levels are not stable at this time, it will be necessary to repeat this procedure in its entirety (steps 1-15) until stable sanitizer readings are achieved.

**IMPORTANT:** If the CLEARRAY® unit is removed from the hot tub or is not operating effectively follow the “without CLEARRAY®” water chemistry parameters as defined by the Pool & Hot Tub Alliance.

16. After adequate sanitizer levels are achieved, close all spa air controls to maximize heat retention when spa is not in use.





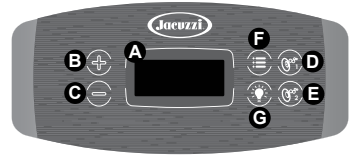

# J-200 Export

## 9.0 Control Functions











2-pump control panel shown

### 9.1 Control Panel Buttons

- A. **LCD Display:** Can display current water temperature (default display), water temperature set point, selected menu functions, and error messages.
- B. **Warmer Button (  ):** Increases water temperature set point. Increments of 1°F or 0.5°C.
- C. **Cooler Button (  ):** Decreases water temperature set point. Increments of 1°F or 0.5°C.
- D. **Jets 1 Button (  ):** Turns jets pump #1 on and off. Press once for low speed; press a second time for high speed; press a third time to turn pump off.
- E. **Jets 2 Button (  ):** Turns high-speed jets pump #2 on and off. Press once to turn pump #2 on; press a second time to turn pump #2 off.
- F. **Menu Button (  ):** Allows access to the programming menus.
- G. **Light Button (  ):** Turns underwater light (if equipped) and accent lights (if equipped) on in one of three random modes or one of seven solid colors. Turns on the exterior lights in a white color only. Refer to Section 10.3 (page 26) for details.

### 9.2 Control Panel Display Icons

- A.  (**Heat icon**): Displayed when the heater is on. Flashing while the heater adjusts to temperature changes.
- B. **R** (**Ready Mode icon**): Allows the hot tub to heat to a set temperature.
- C.  (**Rest Mode icon**): Allows the hot tub to heat only during a filtration cycle. The spa will reach to a set temperature only in a filtration.
- D.  (**Light icon**): Displays when the lights are on.
- E.  (**Cleanup Cycle icon**): Displays when a cleanup cycle is active, page 27.
- F.  (**Jets 1 icon**): Displays when Jets pump 1 is on. Press once for low speed; press again for high speed. The pump activates for 20-minute then turns off.

- G.  (**Jets 2 icon**): Displays when Jets pump 2 is on. The pump activates for 20-minute then turns off.
- H.  **(Temperature High Range icon)**: Indicates that the spa is set to high range temperature between 26.5°C (80°F) and 40°C (104°F).
- I.  **(Temperature Low Range icon)**: Indicates that the spa is set to low range temperature between 18.5°C (65°F) and 37°C (99°F).
- J. **SET (Set icon)**: Displays when in menus that require programming.
- K. **F12 (Filter Cycle icons)**: Displays when the hot tub is running in a filtration cycle. Either F1 (first filter cycle) or F2 (second filter cycle).
- L. **AP (AM or PM icons)**: Displays only when in the Set Time Menu. For AM setting an “A” will be shown. For PM setting a “P” will be shown.

### **Operation Details**

- Temperature Adjustment: Factory default setting is 38°C (100°F).  
High Range 26.5°C (80°F) and 40°C (104°F)  
Low Range 8.5°C (65°F) and 37°C (99°F)
- LED light system: All LED lights run for 2 hours and then automatically shut off.
- Jets 1/Jets 2 Button Operation: Jets run for 20 minutes when activated, then turn off automatically to conserve energy. Simply press either jets button to continue operation for an additional 20 minutes.
- **CLEARRAY** Unit : Will activate anytime the low-speed pump is on.

# J-200 Export

## 9.3 General Spa Features and Controls

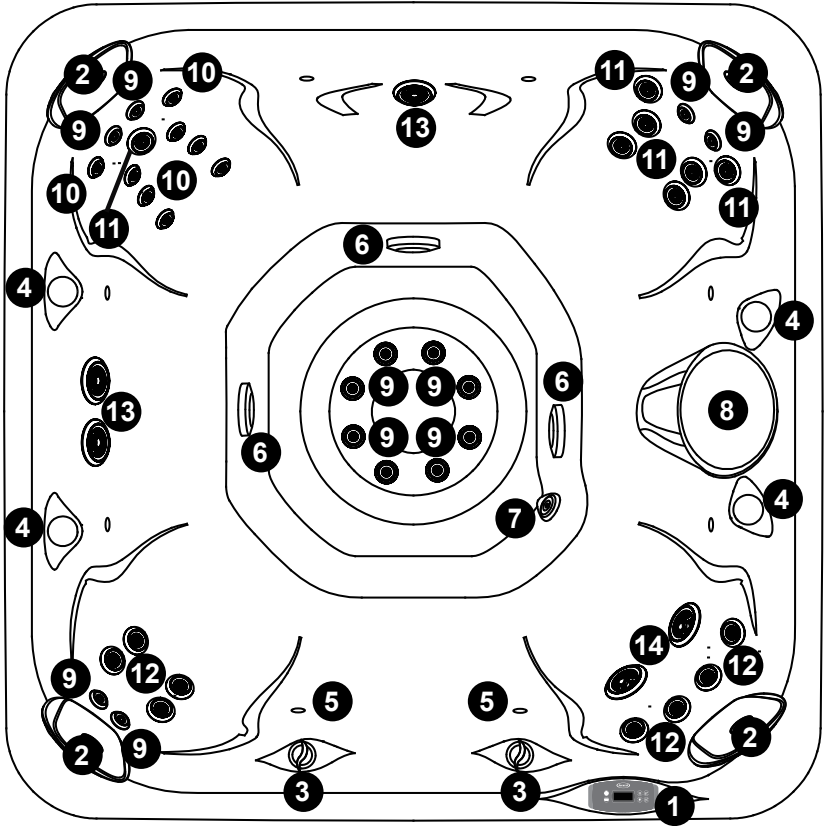

*J-285 model illustrated*

- |  |  |
|--|--|
| 1. Control Panel   | 8. Filter lid with one underlying filter cartridge (Filter requires periodic cleaning) |
| 2. Headrest Pillows (4)  | 9. 2" Direct SL (14)   |
| 3. Air Controls (2)  | 10. 2" Rotate SLR (8)  |
| 4. Cup Holders (4)   | 11. 3" Direct SL3 (7)  |
| 5. LED Lighting System:<br>• Multiple LED accents lights (qty 8) | 12. 3" Rotate SL3R (8)   |
| 6. Suction Fittings  | 13. 5" Direct SL5 (3)  |
| 7. Heater Return/Gravity Drain                                   | 14. 5" Rotate SL5R (2)   |

*Specifications Subject to Change Without Notice.*





## 10.0 Operating Instructions

The spa control system has automatic functions that operate upon start up and normal operation to protect the system. Upon the first power up, the readout displays a sequence of information about the configuration of the hot tub. Then the Priming Mode will begin, page 17.

**Note:** It is common for the heater to turn on after the spa is first filled because tap water is often very cold. If water temperature, at this time, is less than the factory default temperature setting of 38°C (100°F) the heater will turn on and run until the water temperature rises to the factory setting, then turn off.

### 10.1 Setting Water Temperature





The spa's thermostat provides optimum control of water temperature. The temperature set point (set temperature) can be adjusted from 18.5°C (65°F) to 40°C (104°F). To raise the set temperature, press the **WARMER** (  ) button. To lower the set temperature, press the **COOLER** (  ) button. The first press of either **WARMER** (  ) or **COOLER** (  ) button displays the set temperature.

To access the overtemp feature that allows the spa to reach 41°C (106°F) follow the steps below.



**WARNING: RISK OF HYPERTHERMIA (OVER-HEATING) CAUSING SEVERE INJURY, BURNS, WELTS OR DEATH!**  
Water temperature in excess of 40°C (104°F) may injurious to your health.

- A. Raise the temperature to 40°C (104°F)
- B. Press any temperature button, and while the Set Temperature is displayed (flashing):
  - Press and hold the **MENU** (  ) button then;
  - Press the **WARMER** (  ) button at the same time. Press once to raise the temperature to 40.5°C (105°F); press again to raise it to 41°C (106°F).



**Note:** If the temperature is set to 40.5°C (105°F) and you would like to raise the temperature to 41°C (106°F), you will have to repeat the steps above.

- C. When the overtemp feature has been activated, the icon after the temperature will display an "o" as an indicator for being in the overtemp mode.
- D. If the Set Temperature is either 40.5°C (105°F) or 41°C (106°F) and you simply press any temperature button while the Set Temperature is flashing, the Set Temperature will jump to 40.0°C (104°F).

**Note:** If the temperature is manually changed below 40.0°C (104°F) or power is turned off and you would like to raise the temperature to 41°C (106°F) again, you will have to repeat the steps above.

## J-200 Export

### 10.2 Activate Jets Pump

The control panel JETS 1 button activates jets pump 1. The first press activates low speed, the second press activates high speed, and the third press shuts jets pump 1 off. The JETS 2 button activates jets pump 2. The first press activates high speed, the second press turns jets pump 2 off. When manually activated, either pump will automatically turn off after 20 minutes.

### 10.3 Multi-Colored LED Light System Operation



The multi-colored LED light system offers seven constant color variations and three unique random modes for enhanced spa enjoyment. Press the Light button once to activate the first light mode, then continue pressing the button to select one of seven constant colors or random solid color mode as illustrated below. To turn off the light, after the last press of the button wait for more than 5 seconds and then press the light button again. For the exterior lights, they are only on when the lights are activated. The exterior lights display a solid white color only.

**Note:** Anytime the spa light is manually activated, it will remain on for 2 hours then automatically shut off.

Press	Mode/Color	Press	Mode/Color
1st	high speed blend mode	12th	OFF
2nd	OFF	13th	solid Amber color
3rd	low speed blend mode	14th	OFF
4th	OFF	15th	solid Green color
5th	freezes low speed blend mode	16th	OFF
6th	OFF	17th	solid Aqua color
7th	solid Blue color	18th	OFF
8th	OFF	19th	solid Near White color
9th	solid Violet color	20th	OFF
10th	OFF	21st	back to high speed blend mode
11th	solid Red color		

### 10.4 Adjusting Individual Jet Flow

The water flow through certain jets in your spa can be adjusted or turned off by rotating the outside jet ring. Other jets also offer an adjustable center nozzle that allows you to change the water discharge angle. Simply tilt the center nozzle in these jets to the desired angle to customize your personal massage.

**Note:** Always keep at least 6 adjustable jets open at all times to ensure proper filtration characteristics within spa.

### 10.5 Air Controls

Certain jet systems have their own air control. Each control introduces air into the water lines that supply that specific jet group. Simply turn the air control of choice counterclockwise to open or clockwise to close.

**Note:** To minimize heat loss, all air controls should be closed when the spa is not in use. Certain jets may not draw air when jets pump 1 is running in low speed; this is considered normal.

### 10.6 Blow-Out Cycle

This cycle will purge the air from the plumbing lines. The Jets Pump 2 (if equipped) will turn on and run for 1 minute then shut off. This cycle will **only** occur at the beginning of a filter cycle.

### 10.7 Cleanup Cycle

The cleanup cycle begins 30 minutes after the pump is turned off or it times out. The Jets Pump 1 (low speed) and the CLEARRAY will turn on for 30 minutes and then shut off. The duration of the cycle can be programmed from 30 minutes up to 4 hours, page 35.

### 10.8 Optional SmartTub® System

Advances in technology have allowed us to create a better and smarter hot tub. Our SmartTub® system operates on a cellular network. The advantages of this system are:

- A more stable connection to internet for outdoor environment. The SmartTub® device uses much less data than a typical voice connection via cellular networks. We contract through the largest wireless carriers to ensure maximum uptime. The system enables firmware updates via the cell connection so your system's performance will continuously be optimized remotely.
- Maintenance is made easy by alerts sent to your phone.
- Diagnostic alerts are sent to you and your dealer when attention is required.

#### A. Pairing process

1. Download the SmartTub® app from the Google Play store or Apple App store.
2. Open the app and create an account.
3. Locate the SmartTub® sticker next the control panel of the hot tub. You can either scan the QR code with the SmartTub® app or manually input the serial number located below the QR code on the sticker.
4. After you pair the hot tub's serial number to the SmartTub® app, the app will load and connect the hot tub to the internet.
5. Follow the instructions on the app to begin enjoying the benefits of your internet connected hot tub.

**Note:** The first year of data service is included. You will need to renew the subscription after the first year. Please refer to the terms of service and privacy policy links in the SmartTub® app for additional information.

## J-200 Export

### B. Indicator Lights

There are indicator lights on the SmartTub® controller that relay the status of the system. Below are meanings of the lights.

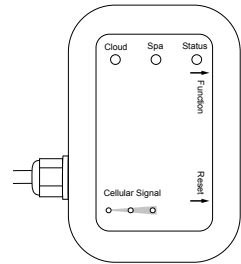

1. Cloud:
  - Blue light on - connected to cloud.
  - Blue light off - not connected to cloud.
2. Spa:
  - Blue light on - connected to spa controller
  - Blue light off - not connected to spa controller
3. Status:
  - Cyan light - breathing (slow pulsing) indicates the status is good.
  - Cyan light - flashing indicates that the system is completing a connection to the cloud.
  - Green light - flashing indicates waiting for a connection to the cellular tower.
  - Dark blue light - flashing indicates a SIM error.
4. Cell signal strength:
  - 3 blue LED lights indicates cell signal strength.











### C. Resetting the SmartTub® controller

Should the SmartTub® controller need to be reset, hold a magnet to the reset label on the side of the SmartTub device.





## 11.0 Menu Features and Programming Instructions

Your hot tub is equipped with menus that allow you to program additional features. By continually pressing the Menu/Select (  ) button you will cycle through the menus as follows:

Current temperature (Main Menu)	
Temp (page 29)	
Mode (page 30)	
Set Time/Time (page 31)	
Flip (page 31)	
Lock (page 32)	
Hold (page 32)	
Filter Cycle 1 (page 33)	
Filter Cycle 2 (page 33)	
Preferences (page 34)	

### 11.1 Adjusting the Temperature

The hot tub is equipped with dual temperature ranges. The high range settings can be used for everyday heating. The low range settings can be used as an away setting. Pressing or holding the  or  buttons will adjust the set temperature. See Preference settings for selecting a Fahrenheit or Celsius display, page 34. The default temperature setting is 38°C (100°F)

**Note:** Automatic Function - Pump 1 low speed activates periodically to circulate the water and determine the water temperature.



#### A. High Range Temperature (default setting)

The high temperature range is between 26.5°C (80°F) and 40°C (104°F). When the spa is in this setting it will display this icon . To adjust the temperature, follow the steps below.







**Note:** If no button is pressed within 5 seconds of each selection the screen will revert back to the Main Menu and the current settings will remain active.



## J-200 Export

1. Press the  or  button to adjust the set temperature. The temperature numbers will start flashing to show the system is ready for adjustments. Once set to the preferred temperature, press  to program the change and return to the Main Menu.



### B. Switching between high and low temperature ranges.

1. From the Main Menu, press the  button to enter the Temperature Menu. Press the  or  button to toggle between the ranges,  or . Once you select the desired range, press  to program the change and return to the Main Menu.

### C. Low Range Temperature

The low range settings are between 18.5°C (65°F) and 37°C (99°F). When the spa is in this setting it will display this icon . This setting is normally used as an away program. To adjust the temperature, follow the steps below.

**Note:** If no button is pressed within 5 seconds of each selection the screen will revert back to the Main Menu and the current settings will remain active.

1. Press the  or  button to adjust the set temperature. The temperature numbers will start flashing to show the system is ready for adjustments. Once set to the preferred temperature, press  to program the change.

## 11.2 Programming the Mode Setting

Your hot tub is equipped with 2 modes of heating. A “**READY**” mode, where the hot tub’s temperature is maintained at all times. A “**REST**” mode, where the hot tub only heats during a filter cycle.





### A. Ready Mode

Allows the heater to heat, at all times, in order to maintain the preset temperature. Indicated by the Ready Mode “**R**” icon on the Main Menu display. Pump 1 low speed activates periodically to circulate the water and determine the spa temperature.

### B. Rest Mode

Allows the heater to heat only during a programmed filter cycle. Indicated by the Rest Mode “” icon on the Main Menu display. If the primary pump has not turned on within an hour, the message “**RUN PUMP FOR TEMP** -- -- --” will appear on the display. Pressing the Jets Pump 2 button will active the pump and heater so the temperature can be sensed and displayed.

### C. Switching between Ready and Rest Mode

From the Main Menu, press the  button twice to enter the Mode Menu. Press the  or  button to toggle between Ready Mode “**R**” and Rest Mode “”. Once the mode is selected, press  to accept the change and return to the Main Menu.

#### D. Ready-in-Rest Mode

When the spa is in a Rest Mode  and the Jets Pump 1 button is pressed, the spa will heat to either the set temperature or for one hour. Both icons will be shown on the display. After the 1-hour time out and automatic clean up cycle the spa will return to Rest Mode.



### 11.3 Adjusting and Setting the Time













The time on the spa can be programmed. This is needed in order for the spa to run during a programmed filter cycle.

- The default time is for 12:00 noon.
- The default setting is for a 12-hour configuration. See Preference settings for selecting a 12-hour or 24-hour display, page 35.
- The time information is not stored. If power is cut to the spa you must reset the time.







#### A. Set Time

**Note:** If no button is pressed within 5 seconds of each selection the screen will revert back to the Main Menu and the current settings will remain active.



1. Press  3 times until you get to the **“SET TIME/TIME”** Menu. The display will scroll **“SET TIME”** at start up or anytime the power to the spa is turned off and on.
2. Press  or  to prepare the system for changes.
3. The display will change from **“SET TIME”** to . The hour will be flashing. Press  or  to adjust the hour. In the upper right-hand corner, an **A** or **P** will display. This indicates either AM or PM.
4. Press  to set the minutes. The display will change from  to . The minutes will be flashing. Press  or  to adjust the minutes. Press  to accept the change and return to the main.
5. To check the time, press the Menu button until you get to the Time Menu. The display will alternate between **“TIME”** and the current time.

#### 11.4 Invert the display

From the Main Menu, press the  button until you reach the **“FLIP”** option. Press  or  to invert the display from  to . Press  to accept the change and return to the main.

## J-200 Export

### 11.5 Locking the Spa









LOCK

Certain functions and features can be locked to prevent unauthorized use.

- Temperature lock: The set temperature and programming settings cannot be adjusted. Jets can be activated. The following menus can be accessed: FLIP, LOCK, UTIL, INFO, and FALT LOG, if equipped. When trying to adjust the temperature, “**LOCK**” will appear.
- Panel lock: All automatic functions will still run but the control panel buttons will not activate. When the panel is locked, the display will show the current temperature but when any button is pressed “**LOCK**” will appear.









#### A. Locking the Temperature

TEMP

1. From the Main Menu, press the  button until you reach the “**LOCK**” option.
2. Press  or  to enter the “**LOCK**” Menu.
3. Press  or  to enter the “**TEMP**” Menu.
4. Press  or  to toggle between “**OFF**” and “**ON**.”
5. Press the  button to accept the change and return to the Main Menu.



#### B. Locking the Panel

PANL

1. From the Main Menu, press the  button until you reach the “**LOCK**” option.
2. Press  or  to enter the “**LOCK**” Menu.
3. Press  or  to enter the “**TEMP**” Menu.
4. Press the  button to enter the “**PANL**” Menu.
5. Press  or  to toggle between “**OFF**” and “**ON**.”
6. Press the  button to accept the change and return to the Main Menu.

#### C. Unlocking the Temperature/Panel







UNLK

1. From the Main Menu, press and hold the  button then slowly press the  button twice. “**UNLK**” will display and after a few seconds the Main Menu will be displayed.
2. If both the temperature and panel are locked, you will need to perform the unlock procedure twice.

### 11.6 Hold (Standby)

HOLD

This feature is used when performing a service or replacing the filters. The setting lasts for an hour unless you manually exit.

1. From the Main Menu, press the  button until you reach the “**HOLD**” option.
2. Press  or  to enter the menu. The following message will keep scrolling until the hour is up or you manually exit, “**HOLDING FOR 1:00.**”
3. To exit the setting before the hour is up, press either the ,  or  button. You will return to the Main Menu.

## 11.7 Programming the Filtration Cycles

The filtration cycles and CLEARRAY® unit are important to ensure healthy water conditions. You can program up to 2 filter cycles.



**Note:** Make sure to set the time so the cycles can run as programmed.

- Before a filter cycle runs, a brief blow-out cycle will active to clear the plumbing lines.
- Run times are adjusted in 1-hour increments. The minutes are adjusted in 15-minute increments.
- The segment being programmed will continually flash.
- If power is cut to the spa, the filtration cycles programming will be stored. The **“SET TIME”** will need to be reprogrammed.



In extreme bitter cold weather, where freezing can occur, we recommend you program the filtration cycles to run for a minimum of 8 hours per day. Refer to the “Winterizing” section on page 40.

### A. Filter Cycle 1

Filter cycle 1 has a default start time for 8:00 PM for 4 hours. To change the setting follow the steps below.































1. From the Main Menu, press the button until you reach the Filter Cycle 1 **FLTR** Menu.
2. Press or to enter the menu. The display will show **BEGN**.
3. Press or to program to start to cycle. The display will show **8:00**. Press or to make adjustments. In the upper right-hand corner, an **A** or **P** will display. This indicates either AM or PM. You must round the clock to change from am to pm.
4. Press the button to move on the minutes. Press or to program the minutes. The display will show **8:15**.
5. Press the button to program the cycle length. The display will show **RUN HRS**. Press or to enter the menu.
6. Press or to program the hour(s) duration of the cycle. The display will show **3:00**.
7. Press the button to program the minutes for the cycle. The display will show **3:30**. Press or to make adjustments.
8. Press the button. The display will show, **“F1 ENDS 11:45.”** The system calculates the end time base of the hours programmed.
9. Press or to accept the changes and return to the Main Menu.

### B. Filter Cycle 2

Filter cycle 2 has a default start time for 8:00 AM for 4 hours. To change the setting follow the steps below.







1. From the Main Menu, press the button until you reach the Filter Cycle 2 **FLTR** Menu.

## J-200 Export

2. Press  or  to enter the menu. The display will show . Pressing  or  will toggle between “OFF” and “ON.” If you select OFF, you will exit the menu. If you select ON, the display will show  and you will proceed to the programming instructions.
3. Press  or  to program to start to cycle. The display will show . Press  or  to make adjustments. In the upper right-hand corner, an **A** or **P** will display. This indicates either AM or PM. You must round the clock to change from am to pm.
4. Press the  button to move on the minutes. Press  or  to program the minutes. The display will show .
5. Press the  button to program the cycle length. The display will show . Press  or  to enter the menu.
6. Press  or  to program the hour(s) duration of the cycle. The display will show .
7. Press the  button to program the minutes for the cycle. The display will show . Press  or  to make adjustments.
8. Press the  button. The display will show, “F2 ENDS 11:45.” The system calculates the end time base of the hours programmed. Press  or  to set the changes.
9. Press the  button to program the cycle and accept the changes. If the Menu button is not pressed, within a couple of seconds the panel will revert to the Main Menu without saving the changes.

### C. Turning off Filter Cycle 2

Filter cycle 2 has a default start time for 8:00 AM for 4 hours. To change the setting follow the steps below.







1. From the Main Menu, press the  button until you reach the Filter Cycle 2  Menu.
2. Press  or  to enter the menu. The display will show .
3. Pressing  or  will toggle between “OFF” and “ON.” Select off then you will exit the menu.

## 11.8 Preferences







This menu allows you select certain display preferences.



### A. Setting the temperature display











1. From the Main Menu, press the  button until you reach “PREF.”
2. Press  or  to enter the menu. The display will show “F/C.”
3. Pressing  or  will toggle between °F or °C.
4. Once you make your selection, press the  button to accept the change.

## B. Setting the time display









1. From the Main Menu, press the  button until you reach **"PREF."**
2. Press  or  to enter the **"F/C"** menu. Then press the  button to enter the time display menu **"24-12."**
3. Pressing  or  will toggle between **"24HR"** and **"12HR."**
4. Once you make your selection, press the  button to accept the change.

## C. Reminders

Your spa is equipped with 3 reminders.







- Change Water occurs every 125 days, page 47.
  - Change Filter occurs every 180 days, page 48.
  - Change UV Bulb occurs every 365 days, page 48.
1. From the Main Menu, press the  button until you reach **"PREF."**
  2. Press  or  to enter the  menu. Then press the  button until you get to the **"REMINDERS"** display.
  3. Press  or  to select and toggle between **"YES"** and **"NO."**
  4. Once you make your selection, press the  button to accept the change.
  5. Once the timer expires and the reminder appears on the display, press  or  to reset the timer.

## D. Cleanup Cycle Duration

1. From the Main Menu, press the  button until you reach **"PREF."**
2. Press  or  to enter the  menu. Then press the  button until you get to the **"CLN UP"** display.
3. Press  or  to move through the duration's settings of 0.5H up to 4.0H, in increments of 30 minutes.
4. Once you make your selection, press the  button to accept the change and revert back to the **"PREF"** Menu.

## E. Poll Cycles Duration - Ready Mode Only

(In order to maintain a constant water temperature, heat as needed, and refresh the temperature display the pumps actives to circulate the water. This is known as "polling." Default setting is ON.)

1. From the Main Menu, press the  button until you reach **"PREF."**
2. Press  or  to enter the  menu. Then press the  button until you get to the **"M8"** display.
3. Press  or  to select and toggle between **"ON"** and **"OFF."**
  - When ON, the poll cycles can vary between 30, 60, 90 or 120 minutes apart.
  - When OFF, the poll cycles are 30 minutes apart.

## J-200 Export

### 12.0 Spa Maintenance

Proper and regular maintenance of your spa will help it retain its beauty and performance. Your authorized Jacuzzi dealer can supply you with all the information, supplies, and accessory products you will need to accomplish this.



#### **DANGER: RISK OF SEVERE INJURY OR DROWNING BY ENTRAPMENT!**

- Keep hair, loose articles of clothing or hanging jewelry away from suction fittings, rotating jets or other moving components to avoid entrapment that could lead to drowning or severe injury.
- Never use the spa unless all suction guards, filter, filter lid, or skimmer assembly are installed to prevent body and/or hair entrapment.
- Never operate or use the spa if the filter, filter lid, or skimmer assembly are broken or any part of the skimmer assembly is missing. Please contact your dealer or nearest service center for service.
- The suction fittings and suction covers in this spa are sized to match the specific water flow created by the pump(s). If it is necessary to replace the suction fittings, suction covers or pump(s), be sure that the flow rates are compatible and are in compliance with the VGB Safety Act, page 2.
- Never replace a suction fitting or suction cover with one rated less than the flow rate marked on the original suction fitting. Using improper suction fittings or suction covers can create a body or hair suction entrapment hazard that may lead to drowning or severe injury.
- Owners must alert all spa users to the potential risk of Hair, Limb, Body, Evisceration (disembowelment), and Mechanical Entrapment, page 6.

#### 12.1 Cleaning The Filters

##### **TO DECREASE DROWNING OR ENTRAPMENT, ALWAYS TURN POWER TO SPA OFF BEFORE CLEANING THE FILTER CARTRIDGE!**

These model spas are equipped with a filter grill, filter canister, and filter cartridge located in the skimmer well. Filtering is accomplished when jets pump #1 turns on in low-speed initiating water flow through the skimmer and polyester mesh filter cartridge. As this happens, suspended particles become trapped on the filter's surface. To ensure optimum performance, it is necessary to remove and clean the filter cartridge once a month or sooner, depending on usage and water quality.



**To Clean Filter:**

1. Turn off power to the spa at the home's breaker panel or select the **"HOLD"** mode (page 32) to disable all spa functions.
2. Lift upward on filter skimmer grill to remove it from mating retainer clips, Figure A.
3. Unscrew and remove the filter canister cap, Figure B
4. Remove the filter cartridge by sliding it straight up from filter the canister, Figure C.
5. Using a garden hose with a high-pressure nozzle, rinse debris from the filter pleats beginning at the top and working your way downward, Figure D. Continue, one section at a time, until you have rinsed all of the filter's pleats.
6. Reinstall filter cartridge back onto filter canister, Figure F.
7. Reinstall filter cover by sliding it down into position over mating spa retainer clips, Figure G. Turn spa power back on after skimmer cover is installed.

**⚠ DANGER: TURN POWER TO SPA OFF! TO DECREASE ⚠**  
**RISK OF DEATH, DROWNING, OR ENTRAPMENT,**  
**NEVER OPERATE SPA WHEN FILTER IS NOT PROPERLY**  
**INSTALLED OR IF SKIMMER ASSEMBLY IS DAMAGED OR**  
**ALTERED!**

Figure A

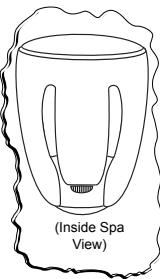

Figure B

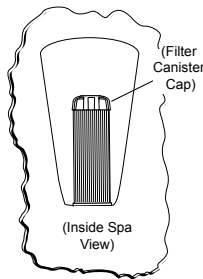

Figure C

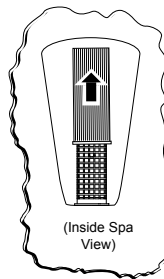

Figure D

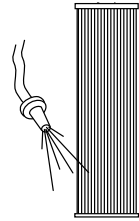

Figure E

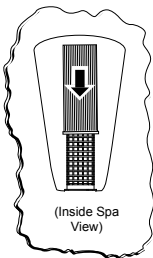

Figure F

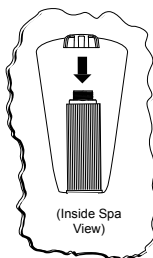
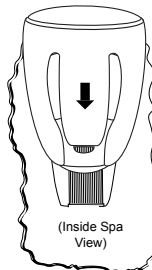

Figure G



## J-200 Export

Periodically, the filter cartridge will need a more thorough cleaning to remove imbedded oils and minerals. For this, we suggest cleaning as illustrated followed by soaking the filter overnight in a plastic container filled with a solution of water and specially formulated filter cleanser available from your authorized Jacuzzi dealer. The average life expectancy of each filter is approximately two years with proper care and water quality maintenance. Replacement cartridges may be purchased from your authorized Jacuzzi dealer.

### 12.2 Draining and Refilling

About every 3 months, you will want to replace the spa's water. The frequency depends on a number of variables including the amount of use, attention paid to water quality maintenance, etc. You will know it is time for a change when you cannot control sudsing and/or you can no longer get the normal feel or sparkle to the water even though the key water balance measurements are all within the proper parameters.

**CAUTION! READ THIS BEFORE DRAINING:** To prevent damage to the spa's components, **turn off power to the spa at the circuit breaker before draining it.** Do not turn the power back on until your spa has been refilled.

**CAUTION:** There are certain precautions to keep in mind when draining your spa. If it is extremely cold, and the spa is outdoors, freezing could occur in the lines or the equipment, see "WINTERIZING" (page 40). On the other hand, if it is hot outdoors, do not leave the spa's surface exposed to direct sunlight.

To drain your spa, perform the following steps (actual drain may vary from one shown). Turn off power to spa at breaker.

1. Remove the front synthetic cabinet, page 13. Locate the drain valve.
2. Cut zip tie(s) and pull drain hose from equipment area (Figure A).
3. Hold drain hose above water line, then unthread drain cap (1) from hose using a counterclockwise rotation (Figure B). Place drain hose on ground to start drain, making sure to direct water away from spa. If equipped, turn valve (2) clockwise to open the valve.
4. After spa is drained, reinstall drain cap on drain hose fitting until finger tight! If equipped, turn valve (2) counterclockwise to close the valve. **DO NOT OVERTIGHTEN!**
5. Place drain hose back inside the spa equipment bay (Fig. A).
6. Reinstall synthetic cabinet and screws, then refer to the "Spa Fill Up Procedure" (page 17).

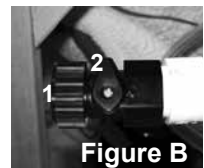

### **12.3 Pillow Care**

Remove and clean each headrest by gently grasping both ends in each hand and pulling upward to release each pillow “snap.” To reinstall, simply “snap” each pillow back into place. Clean as needed with soapy water using a cloth or soft-bristle brush. Always remove the pillows when adding chemical shock treatment to the spa water. The pillows can be returned to the spa when the sanitizer reading is stable as recommended on the inside cover of the manual.

### **12.4 Cleaning The Spa Interior**

To preserve the sheen of your spa’s surface, it is crucial that you avoid using abrasive cleaners or cleaners which have adverse chemical effect on the surface. If you are not certain as to the suitability of a particular cleanser, consult your authorized Jacuzzi dealer. Regardless of the cleanser used, use extreme care to assure that no soap residue is left on the surface. This could cause severe sudsing when the spa is refilled.

### **12.5 Cover Care and Maintenance**

Covers distributed by Jacuzzi Hot Tubs have PROLAST™/PROLAST™ Extreme encasement. The PROLAST™/PROLAST™ Extreme encasement also referred to as the cover “skin” is attractive and durable. Regular monthly cleaning is strongly recommended and may increase the longevity of your cover. Jacuzzi chemicals are for use in the U.S. only.

**Note:** It is highly recommended that you DO NOT put the seam over the control panel. This will cause premature failure of the control system.

#### **A. To Clean and Care for the Cover**

To clean and condition the encasement (cover skin):

1. Use a garden hose to remove any debris.
2. Using a large sponge or soft bristle brush, use diluted or mild soap to gently scrub the top.
3. Rinse and clean and do not allow soap to dry on the cover. Do not use soap on the underside of the cover.
4. Do not use any solvents, abrasive cleaners or strong detergents. Do not use products that contain silicone or alcohol.

#### **B. Additional Care and Maintenance Instructions:**

1. Debris can accumulate on the spa cover. Removal of snow or other debris will help to avoid breakage of the foam cores.
2. Be sure to lock the cover straps to secure the cover from unwanted or accidental entry.
3. Do not place heavy objects on the cover.
4. Do not walk, sit or stand on the cover.
5. Do not drag or use the flaps/skirt or the cover lock straps to remove the cover.
6. Use only recommended cover lift systems.
7. Use only chemicals and cleaners recommended by Jacuzzi.
8. Remember to keep spa covered when not in use. Maintaining proper water levels assures efficient operation and efficient electrical usage.

## J-200 Export

9. Do not expose your spa to the sun for extended periods of time as UV rays can damage the interior surface.
10. Use caution when removing cover. Before removing cover, assure all locks have been released to avoid lock breakage and or cover strap damage.

### 12.6 Maintaining The Synthetic Cabinet

Your new spa's synthetic cabinet requires little or no maintenance of any kind. To clean, simply wipe cabinet with a clean towel and mild soap solution.



**CAUTION:** Never spray cabinet with a garden hose for any reason since this action may induce an electrical short in the spa's electrical equipment.

### 12.7 Winterizing

Your Jacuzzi spa is designed to automatically protect itself against freezing when operating properly. During periods of severe freezing temperatures, you should check periodically to be certain that the electrical supply to the spa has not been interrupted. In extreme, bitter cold weather less than 32°F (0°C), program the filtration cycles to run for a minimum of 8 hrs per day to prevent freezing (page 33). If you do not intend to use your spa or if there is a prolonged power outage during periods of severe freezing temperatures, **it is important that all water be removed from the spa and equipment to protect against damage from freezing.**

**Expert winterization of your spa is highly recommended, contact your authorized Jacuzzi dealer.** In emergency situations, damage can be **minimized** by taking the following steps:

**CAUTION: TURN OFF POWER TO HOT TUB!**

Follow the directions on page 38 for draining the spa.

1. Turn off power to the spa.
2. As the water level drops below the seats, use whatever means necessary to get the water out of the recessed seating areas and into the footwell, such as a wet/dry vacuum.
3. Open all the air controls and leave them open until you resume use of the spa, page 27.
4. As the water level drops below the seats, use whatever means necessary to get the water out of the recessed seating areas and into the footwell, such as a wet/dry vacuum.
5. When the water level ceases to drop, use whatever means available to remove any remaining water from the footwell, such as a wet/dry vacuum.
6. Remove the synthetic cabinet panel under the control panel and locate the drain plugs on the front of the pump(s), (Figure A, page 15). Remove plugs to allow water to drain out of pumps and heater.

**Note:** Approximately one to two gallons will be released during this procedure. Use a wet/dry vacuum or other means to keep this from flooding the equipment compartment. Replace the drain plugs.

7. Loosen hose clamp at bottom of CLEARRAY® unit and pull hose off of CLEARRAY fitting (twist the hose back and forth while pulling downward). Tip hose down and allow to drain. Then reinstall hose and clamp. Remove the cover of the CLEARRAY unit to access the UV bulb and quartz tube. Remove and store the UV bulb in a safe location. Remove and dry off the quartz tube then reinstall it. Depending on the length of time, consider replacing the UV bulb when you resume use of your hot tub.
8. Re-install synthetic cabinet side panel and cover spa so that no casual moisture can enter into it.

Consult your authorized Jacuzzi dealer if you have any questions regarding winter use or winterizing.

### **12.8 Restarting Your Spa in Cold Weather**

If you want to start up your spa after it has sat empty for a time in freezing temperatures, be aware that the water remaining in certain sections of the piping may still be frozen. This situation will block water flow preventing the spa from operating properly and possibly damaging the equipment. We recommend you consult your authorized Jacuzzi dealer for guidance before attempting to re-start your spa under these conditions.

## **13.0 Water Quality Maintenance**

To decrease the risk of contracting a waterborne illness (e.g. an infection, bacteria or virus) and/or respiratory ailments, maintain water quality within specified limits. This will enhance your enjoyment and prolong the life of the hot tub's equipment. Doing so requires regular attention because the water chemistry involved is a balance of several factors. Procrastination in regard to water maintenance will result in poor and potentially unhealthful conditions for soaking and even damage to your hot tub investment. For specific guidance on maintaining water quality, consult your Authorized Jacuzzi dealer who can recommend appropriate chemical products for sanitizing and maintaining your hot tub.



**WARNING: FAILURE TO MAINTAIN WATER QUALITY CAN RESULT IN:**

- Increase risk of contracting a waterborne illness (e.g. an infection bacteria or virus) and/or respiratory ailments.
- Damage the equipment, components and spa shell, which are not covered under the hot tub's warranty.

**CAUTION:** Never store hot tub chemicals inside the hot tub's equipment bay. The equipment bay may reach elevated temperatures, this is where high voltage electronic devices are located. This area is not intended for storage of any kind.

## **J-200 Export**

### **13.1 pH Control**

pH is a measure of relative acidity or alkalinity of water and is measured on a scale of 0 to 14. The midpoint of 7 is said to be neutral, above which is alkaline and below which is acidic. In spa water, it is very important to maintain a slightly alkaline condition of 7.4 to 7.6. Problems become proportionately severe the further outside of this range the water gets. A low pH will be corrosive to metals in the spa equipment. A high pH will cause minerals to deposit on the interior surface (scaling).

In addition, the ability of the sanitation agents to keep the spa clean is severely affected as the pH moves beyond the ideal range. That is why almost all spa water test kits contain a measure for pH as well as the sanitizer.

### **13.2 Sanitizing**

To destroy bacteria and organic compounds in the spa water, a sanitizer must be used regularly. Chlorine and bromine are the two most popular sanitizers used to date. Many other additives are available for your spa. Some are necessary to compensate for out-of-balance water, some aid in cosmetic water treatment and others simply alter the feel or smell of the water. Your authorized Jacuzzi dealer can advise you on the use of these additives. When adding spa shock (chlorine or non-chlorine) or pH balancing chemicals activate the jets pump(s) and leave the spa cover open for a minimum of 20 minutes. By doing this you will allow excessive chemical vapors to exit the spa, protecting pillows and plastic knobs from chemical attack.

**WARNING: RISK OF PERSONAL INJURY, DROWNING OR ENTRAPMENT!** Never leave your hot tub unattended for any reason while the cover is open and accessible, especially to small children and animals!

**CAUTION: RISK OF PERSONAL INJURY OR SPA DAMAGE!** Never add chlorine tablets (trichlor) or acid to your hot tub for any reason! These chemicals may damage components within your hot tub, burn or irritate your skin, create a rash and void the manufacturer warranty for your spa.

## 13.3 CLEARARRAY®

Your new hot tub has the CLEARARRAY System installed.

The CLEARARRAY System is an exclusive technology utilizing ultraviolet light to help keep your water clean\*. The ballast is the power supply for the CLEARARRAY; it has two LED indicator lights, the green indicating incoming power flow and the red indicating the system is properly working. CLEARARRAY is standard for all models.

**Note:** The CLEARARRAY only runs when pump 1 is on low speed for an automatic function, a heat call or a filter cycle.

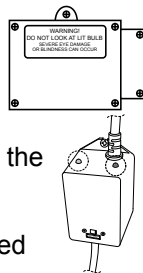

After a year the bulb must be replaced. A message will appear on the LCD display when the time allotted has expired. In order to clear the message, a new UV bulb needs to be installed and the timer must be reset (page 35).

**Note:** In order to access the CLEARARRAY unit, the front synthetic panel must be removed.



### WARNINGS:

- Do not operate the UV-C emitter when it is removed from the appliance enclosure.
- This appliance contains a UV-C emitter.
- Unintended use of the appliance or damage to the housing may result in the escape of dangerous UV-C radiation. UV-C radiation may, even in little doses, cause harm to the eyes and skin.
- Appliances that are obviously damaged must not be operated.
- Read the maintenance instructions before opening the appliance.

\*Clean is defined as the removal of microscopic (to 30  $\mu\text{m}$  level) debris from the water. Ozone aids in the grouping of small debris. Once combined, the debris can be more easily caught by the filtration process.

## J-200 Export

### 13.4 CLEARRAY® Lamp Replacement and Quartz Tube Maintenance

**Important:** It is **MANDATORY** that the UV bulb is replaced and the quartz tube be cleaned every 12 months to maintain optimum performance.

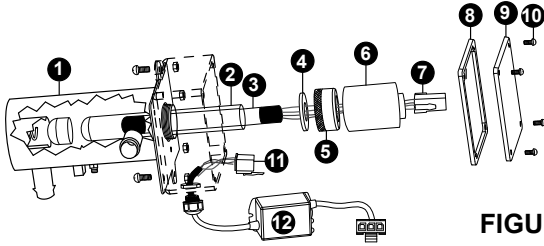

FIGURE 1



**DANGER:** TURN THE SPA BREAKER TO THE OFF POSITION!



**DANGER:** DRAIN THE SPA IF YOU ARE REPLACING OR CLEANING THE QUARTZ TUBE!



**WARNING:** ALLOW LAMP TO COOL DOWN PRIOR TO REMOVING FROM QUARTZ TUBE.



**DANGER:** NEVER LOOK AT THE LIT BULB. THIS CAN CAUSE SEVERE EYE DAMAGE OR BLINDNESS.

#### UV BULB REPLACEMENT AND QUARTZ TUBE MAINTENANCE:

**Note:** Location of CLEARRAY unit and connection may vary by model.

1. Turn the breaker to the spa OFF. DRAIN YOUR SPA.

**Note:** If you are only replacing the UV bulb then the spa does not have to be drained. You will need to drain it if you are replacing or cleaning the quartz tube.

2. Once the UV bulb has cooled off remove the CLEARRAY unit enclosure cover (9) and gasket (8) by removing the four screws (10). This will expose the UV bulb and connections, Figure 2.

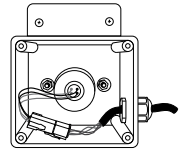

FIGURE 2



**DANGER:** NEVER REMOVE COVER WITHOUT FIRST TURNING OFF AT POWER SOURCE AND DRAINING THE SPA.

FIGURE 3

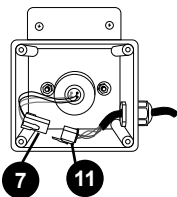

FIGURE 4

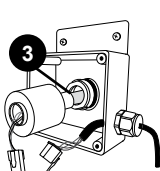

FIGURE 5

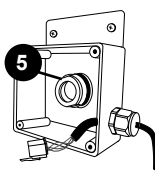
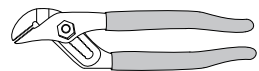
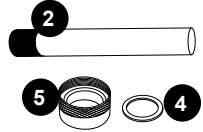

FIGURE 6





3. Disconnect UV bulb socket (7) from the power cord socket (11), Figure 3.
4. Slowly remove the UV bulb (3) out of the quartz tube, Figure 4.
5. Remove the quartz seal compression nut (5) by turning it **counterclockwise**, Figure 5. Use a pair of channel-lock pliers if needed, Figure 6. You will notice that there is a stainless steel compression washer (4) which slides over the quartz tube, save the washer (4) for later use, Figure 7.



**FIGURE 7**

6. Now you are ready to clean or replace the quartz tube (2). For cleaning the quartz tube (2), follow steps 7 and 8 then proceed from step 9. For replacing quartz tube (2), skip steps 7 and 8 and proceed from step 9.
7. **Cleaning quartz tube:** Clean the quartz tube by wiping, until clear, using a paper towel or a dry cotton cloth. If needed, a household tub and shower lime removal product can be used.



**WARNING:** Do not use abrasive cleaners as they can scratch the quartz tube surface.

8. Rinse the quartz tube with clean water to completely remove any cleaning products that were used in step 7.
9. **Replacing quartz tube:** You will notice that the new quartz tube does not have a black cushion on the domed end as the old quartz tube does. This is normal as the cushion was provided with the original quartz tube to protect it from breakage during transportation. Place the new quartz tube (2) into the water chamber (1) with the domed end first making sure it is inserted and seated inside the quartz end holder. Only a small portion will be exposed when it is seated correctly.
10. Reinstall the compression washer (4) over the open end of the quartz tube (2).
11. Reinstall and hand tighten the quartz seal compression nut (5) by turning it **clockwise**.
12. Refill your spa.
13. **System Test 1:** Assure there is no water dripping from the seal compression nut (5). If water is visible, STOP and tighten the compression nut (5) using a pair of channel lock pliers to a maximum of 1/4 turn. If that does not fix the leak, then repeat quartz tube maintenance process from step 1 through step 12. Make sure there is no water leaking before proceeding to step 14.
14. **System Test 2:** Reconnect the CLEARRAY unit to the controller. Turn breaker back ON. Turn on the pump to circulate the water through the CLEARRAY System. Wait for 5 minutes and assure no water is dripping. If water is visible, STOP, fix the leak by repeating quartz tube maintenance process from step 1 through step 13. **Make sure there is no water visible. Turn the pump and breaker OFF BEFORE proceeding to step 15.**

## J-200 Export

15. Reconnect the UV bulb socket (7) to the power cord socket (11) make sure you use the latex glove provided when handling the UV bulb.



**WARNING: DO NOT TOUCH THE NEW UV BULB WITH YOUR BARE HAND.** Oil on your skin will cause hot spot on the UV bulb and shorten the life of your UV bulb. Use the provided latex glove to handle the UV bulb.

16. Slide the new UV bulb (3) back inside the quartz tube.
17. Reinstall the black bulb boot (6) back over the quartz seal compression nut (5).
18. Reinstall the enclosure cover (9) with gasket (8) and secure with the screws.
19. Properly dispose of the old UV bulb.



**WARNING:** This CLEARRAY System includes a UV bulb, which contains mercury. Dispose of the bulb in accordance with disposal laws. See [www.lamprecycle.org](http://www.lamprecycle.org).

20. Once power is activated you can check the ballast (12), Figure 8, to see if the CLEARRAY System is functioning; it has two LED indicator lights the green indicating incoming power flow and the red indicating the system is properly working.

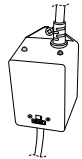

**FIGURE 8**

## 14.0 Error Conditions/Error Messages

Your spa has a self-diagnostic control system. The system will automatically display the following if a problem is detected. **Always insist on genuine Jacuzzi replacement parts.**

### A. General Messages

1.  RUN PMPS PURG AIR

**Priming Mode - M019:** Each time the spa is powered up, it will enter a Priming Mode. The purpose of Priming Mode is to allow the user to run each pump and manually verify that the pumps are primed (air is purged) and water is flowing. This typically requires observing the output of each pump separately and is generally not possible in normal operation. Priming Mode last about 4 minutes, but you can exit it earlier by pressing any Temp button. The heater is not allowed to run during Priming Mode.

2.  ----F or ----C

**Water Temperature is Unknown:** After the pump has been running for 1 minute, the temperature will be displayed.

3.  SSF TOO COLD

**Too Cold - Freeze Protection:** A potential freeze condition has been detected, or the Aux Freeze Switch has closed, and all pumps are activated one at a time. All pumps are ON for at least 4 minutes after the potential freeze has ended, or when the Aux Freeze Switch opens. This is an operational message, not an error indication.

**Note:** In some cases, pumps may turn on and off and the heater may operate during Freeze Protections.

4.  WATR TOO HOT

**Water is too Hot (OHS) - M029: DO NOT ENTER THE WATER.**

One of the water temp sensors has detected spa water temp 43.3°C (110°F) and spa functions are disabled. System will auto reset when the spa water temp is below 108°F (42.2°C). Check for extended pump operation or high ambient temp.



**WARNING: RISK OF HYPERTHERMIA (OVER-HEATING)  
CAUSING SEVERE INJURY, BURNS, OR WELTS.**

### B. Reminders Messages

1.  CHNG WATR

**Change Water:** The change water timer has expired. The spa needs to be drained and refilled. The display will alternate between “**CHNG WATR**” and the normal display. The timer for this reminder will need to be reset, page 35.

## J-200 Export

2. 

Change Filter: The change filter timer has expired. The filter needs to be inspected. It is time to clean or replace the filter. The display will alternate between “**CHNG FLTR**” and the normal display. The timer for this reminder will need to be reset, page 35.

3. 

Change UV Bulb: The change UV bulb timer has expired. The display will alternate between “**CHNG UV BULB**” and the normal display. The UV bulb must be replaced. The timer for this reminder will need to be reset, page 35.

### C. Heater Related Messages

**Note:** Check for low water level, suction flow restrictions, closed valves, trapped air, too many closed jets and pump prime.

1. 

Heater Flow is Reduced (HFL) - M016: There may not be enough water flow through the heater to carry the heat away from the heating element. Heater startup will begin after about 1 minute.

2. 

Heater Flow is Reduced (LF) - M017: There is not enough water flow through the heater to carry the heat away from the heating element and the heater has been disabled. After the problem has been resolved, you must press any button to reset and begin heater start up.

3. 

Heater may be Dry (dr) - M028: Possible dry heater, or not enough water in the heater to start it. The spa is shut down for 15 minutes. Press any button to reset the heater start up.

4. 

Heater is Dry - M027: There is not enough water in the heater to start it. The spa is shut down. After the problem has been resolved, you must press any button to reset and restart heater start up.

5. 

Heater is too Hot (OHH) - M030: One of the water temp sensors has detected 47.8°C (118°F) in the heater and the spa is shut down. You must press any button to reset when water is below 42.2°C (108°F).





**WARNING: RISK OF HYPERTHERMIA (OVER-HEATING)  
CAUSING SEVERE INJURY, BURNS, OR WELTS.**



6. 

A Reset Message may Appear with other Messages: Some errors may require power to be removed and restored.

**D. Sensor Related Messages**

1. 

Sensor Balance is Poor - M015: The temperature sensors may be out of sync by or 1.5°C (3°F). Call for Service.
2. 

Sensor Balance is Poor - M026: The temperature sensors are out of sync. The Sensor Balance is Poor fault has been established for at least 1 hour. Call for Service. The message can be reset by pressing any button.
3. 

Sensor Failure - Sensor A: M031, Sensor B: M028: A temperature sensor or sensor circuit has failed. Call for Service.

**E. Miscellaneous Messages**

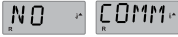
1. 

No Communications: The control panel is not receiving communication from the system. Call for Service.
2. 

°F or °C is replace by °T: The Control System is in Test Mode. Call for Service.

**F. System Related Messages**

1. 

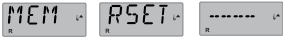
Memory Failure - Checksum Error - M022: At power up, the system has failed the Program Checksum test. This indicates a problem with the firmware (operation program) and requires a service call.
2. 

Memory Warning - Persistent Memory Reset - M021: Appears after any system setup change. Contact your dealer or service organization if this message appears on more than one power up or it if appears after the system has been running normally for a period of time.
3. 

Configuration Error - Spa will not Start up: Contact your dealer or service organization.
4. 

A Pump Appears to be Stuck ON - M034: Water may be overheated. **POWER DOWN THE SPA. DO NOT ENTER THE WATER.** Contact your dealer or service organization.

## J-200 Export

5.  H0T FALT CALL FOR SRVC

A Pump Appears to have been Stuck ON when spa was last powered  
- M035: **POWER DOWN THE SPA. DO NOT ENTER THE WATER.**  
Contact your dealer or service organization.

## 15.0 Troubleshooting Procedures

In the event your Jacuzzi spa is not working the way it should, please first review all the installation and operating instructions in this manual and check the message on the panel display. If you are still not satisfied it is working properly, please follow the appropriate troubleshooting instructions below.

**Note:** If any of the supply cords to the accessories are damaged, they must be replaced by authorized service personnel. Contact your authorized Jacuzzi dealer or qualified service technician. **Always insist on genuine Jacuzzi replacement parts.**

### 15.1 None of the Components Operate (e.g. Pump, Light)

Check the following:

1. Is there power to the spa?
2. Is the household circuit breaker tripped?
3. Contact your authorized Jacuzzi dealer or qualified service technician.

### 15.2 Pump Does Not Operate But Light Does

Press the JETS 1 button:

1. If no water movement is detected, make sure power is going to the spa and check the water level. If it does not solve the problem, contact your authorized Jacuzzi dealer.
2. The main pump operates but no water flows to jets. Pump may not be properly primed (page 17). This can happen after the spa is drained and refilled.

### 15.3 Poor Jet Action

1. Make sure jets are in the full open "on" position (page 26).
2. Press the JETS 1 button to make certain pump #1 is on.
3. Open all air controls to their full on position (counterclockwise).
4. Check for dirty filter. Clean, if necessary (Section 12.1, page 36).

### 15.4 Water is Too Hot

Reduce thermostat setting.

**15.5 No Heat**

1. Check thermostat setting.
2. Keep the spa cover in place while heating.
3. Check the settings to see if your spa is in “**REST**” heating mode (page 30).

Should checking the above steps fail to correct the problem, please call your dealer so that they may arrange service. We build the best spas in the industry. Nonetheless, we are always striving to improve the quality and features of our products.

Your input as a Jacuzzi spa owner is a cherished part of this process. If you have any comments or suggestions, or if you wish to be informed on any new products for your spa, please write to us.

**CONGRATULATIONS** on your good taste and welcome to the happiest and most relaxed family in the world!

# J-200 Export

## 16.0 Circuit Board Diagrams

### 16.1 Export 50 Hz 1-Pump Models

This wiring diagram is used for all 1 Pump Export models.

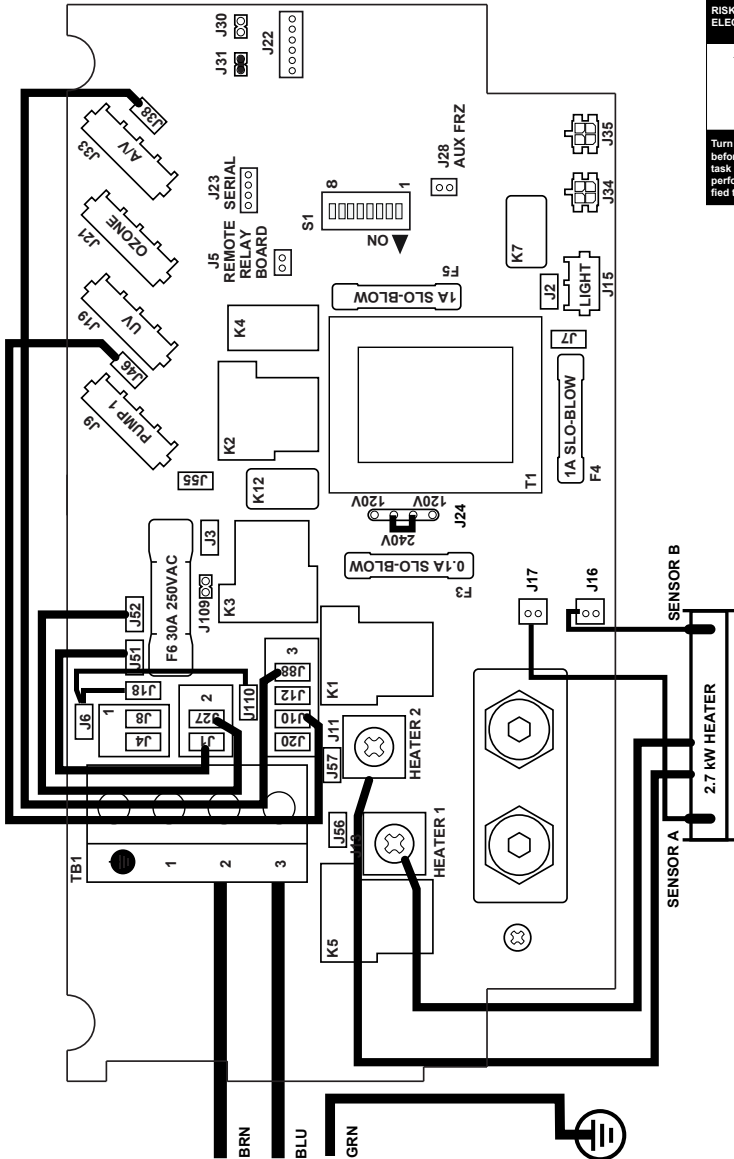

**⚠ DANGER**  
RISK OF SHOCK OR ELECTROCUTION!

Turn power off before servicing. This task should only be performed by a qualified technician.

FOR 2 OR 3 SERVICE SEE WIRE DIAGRAM

WIRE STRIP LENGTH  
11/16" (0.69", 17.5mm)  
BARE METAL

HAND TIGHTEN WITH PHILIPS SCREWDRIVER.



**16.2 Jumper wires and Dip Switch Settings for 1-Pump Single Phase**

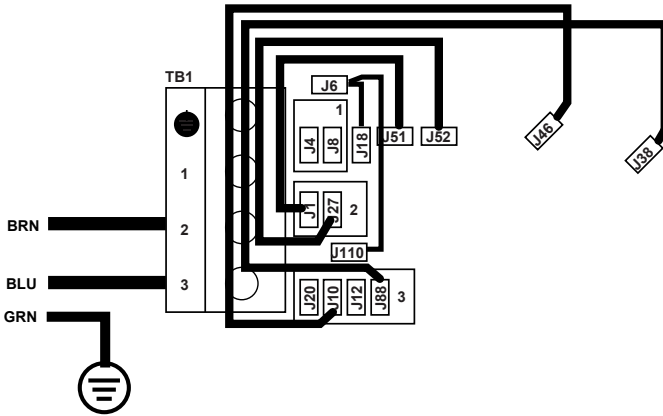

**DEFAULT SETTING\*\***

ON Position	S1 SWITCH	OFF Position
NOT ASSIGNED	8 ▶	NOT ASSIGNED
NOT ASSIGNED	7 ▶	NOT ASSIGNED
MEMORY RESET*	6 ▶	STORE SETTINGS*
SPECIAL AMPERAGE RULE ON	5 ▶	SPECIAL AMPERAGE RULE OFF
5 MIN HTR COOL DOWN (GAS)	4 ▶	1 MIN HTR COOL DOWN (ELEC)
ADD 2 HS PUMPS WITH HEAT	3 ▶	DON'T ADD 2 HS PUMPS W/ HEAT
ADD 1 HS PUMP WITH HEAT	2 ▶	DON'T ADD 1 HS PUMP W/HEAT
TEST MODE ON	1 ▶	TEST MODE OFF

\*Switch #6 should be set to OFF upon final installation. All unused switches should be OFF.

Service	DIP SWITCH NUMBER							
	1	2	3	4	5	6	7	8
1x16A**	OFF	OFF	OFF	OFF	OFF	OFF	OFF	OFF
1x32A	OFF	ON	OFF	OFF	OFF	OFF	OFF	OFF

\*\*16A Service is the default setting

# J-200 Export

## 16.3 Jumper wires and Dip Switch Settings for 1-Pump 2 out of 3-phase

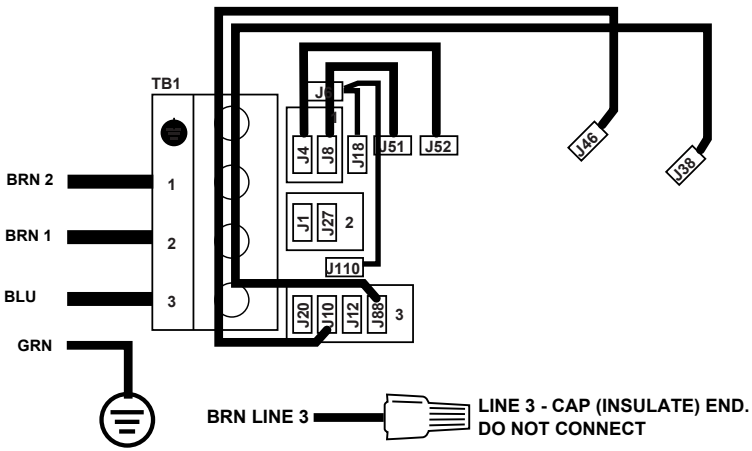

ON Position	S1 SWITCH	OFF Position
NOT ASSIGNED	8 ►	NOT ASSIGNED
NOT ASSIGNED	7 ►	NOT ASSIGNED
MEMORY RESET*	6 ►	STORE SETTINGS*
SPECIAL AMPERAGE RULE ON	5 ►	SPECIAL AMPERAGE RULE OFF
5 MIN HTR COOL DOWN (GAS)	4 ►	1 MIN HTR COOL DOWN (ELEC)
ADD 2 HS PUMPS WITH HEAT	3 ►	DON'T ADD 2 HS PUMPS W/ HEAT
ADD 1 HS PUMP WITH HEAT	◄2	DON'T ADD 1 HS PUMP W/HEAT
TEST MODE ON	1 ►	TEST MODE OFF
*Switch #6 should be set to OFF upon final installation. All unused switches should be OFF.		

DIP SWITCH NUMBER							
1	2	3	4	5	6	7	8
OFF	ON	OFF	OFF	OFF	OFF	OFF	OFF

### 16.4 Export 50Hz 2-Pump Models

This wiring diagram is used for all 2 Pump Export models.

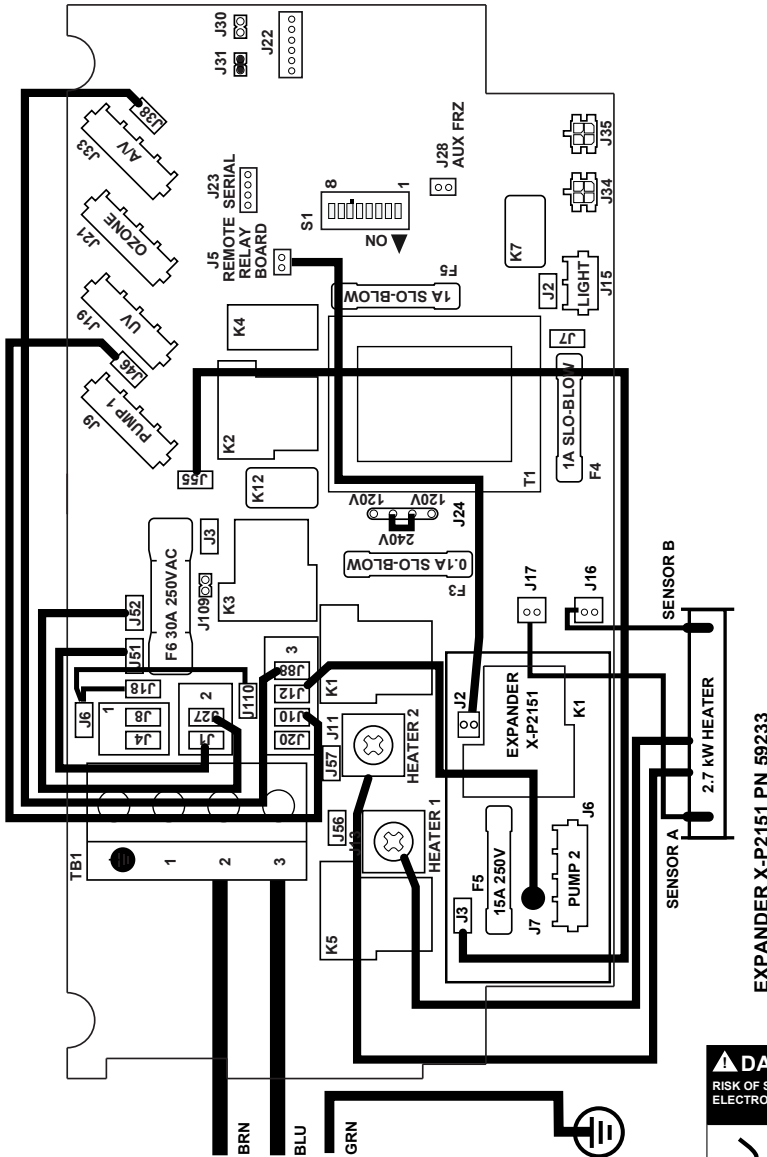

EXPANDER X-P2151 PN 59233

LOCATION	DEVICE	VOLTS	AMPS	FROM	TO
J6	PUMP 2	240V	7A	J7	AREA 3
				J3	J55

FOR 2 OR 3 SERVICE SEE WIRE DIAGRAM

WIRE STRIP LENGTH  
11/16" (0.69"), 17.5mm)  
BARE METAL

HAND TIGHTEN WITH PHILIPS SCREWDRIVER.

**⚠ DANGER**  
RISK OF SHOCK OR ELECTROCUTION!

Turn power off before servicing. This task should only be performed by a qualified technician.

# J-200 Export

## 16.5 Jumper wires and Dip Switch Settings for 2-Pump Single Phase

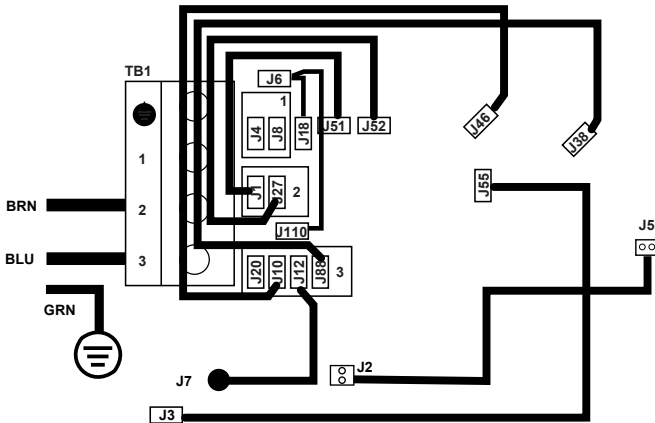

**DEFAULT SETTING\*\***

ON Position	S1 SWITCH	OFF Position
3-PHASE SPCL AMP RULE ON	8 ►	3-PHASE SPCL AMP RULE OFF
NOT ASSIGNED	7 ►	NOT ASSIGNED
MEMORY RESET*	6 ►	STORE SETTINGS*
SPECIAL AMPERAGE RULE ON	5 ►	SPECIAL AMPERAGE RULE OFF
5 MIN HTR COOL DOWN (GAS)	4 ►	1 MIN HTR COOL DOWN (ELEC)
ADD 2 HS PUMPS WITH HEAT	3 ►	DON'T ADD 2 HS PUMPS W/ HEAT
ADD 1 HS PUMP WITH HEAT	◄ 2	DON'T ADD 1 HS PUMP W/HEAT
TEST MODE ON	1 ►	TEST MODE OFF

\*Switch #6 should be set to OFF upon final installation. All unused switches should be OFF.

Service	DIP SWITCH NUMBER							
	1	2	3	4	5	6	7	8
1x16A	OFF	OFF	OFF	OFF	OFF	OFF	OFF	OFF
1x32A**	OFF	ON	OFF	OFF	OFF	OFF	OFF	OFF

\*\*Default setting

### EXPANDER X-P2151 PN 59233

LOCATION	DEVICE	VOLTS	AMPS	FROM	TO	FROM	TO
J6	PUMP 2	240V	7A	J7	AREA 3	J3	J55

16.6 Jumper wires and Dip Switch Settings for 2-Pump 2 out of 3-phase

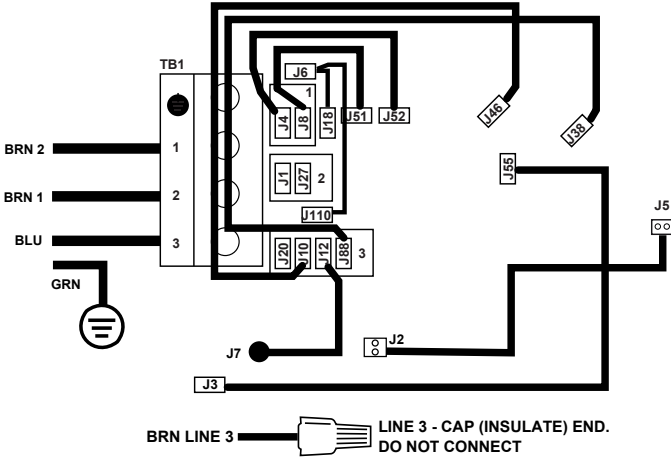

ON Position	S1 SWITCH	OFF Position
3-PHASE SPCL AMP RULE ON	8 ►	3-PHASE SPCL AMP RULE OFF
NOT ASSIGNED	7 ►	NOT ASSIGNED
MEMORY RESET*	6 ►	STORE SETTINGS*
SPECIAL AMPERAGE RULE ON	5 ►	SPECIAL AMPERAGE RULE OFF
5 MIN HTR COOL DOWN (GAS)	4 ►	1 MIN HTR COOL DOWN (ELEC)
ADD 2 HS PUMPS WITH HEAT	◄3	DON'T ADD 2 HS PUMPS W/ HEAT
ADD 1 HS PUMP WITH HEAT	◄2	DON'T ADD 1 HS PUMP W/HEAT
TEST MODE ON	1 ►	TEST MODE OFF

\*Switch #6 should be set to OFF upon final installation. All unused switches should be OFF.

DIP SWITCH NUMBER							
1	2	3	4	5	6	7	8
OFF	ON	ON	OFF	OFF	OFF	OFF	OFF

EXPANDER X-P2151 PN 59233

LOCATION	DEVICE	VOLTS	AMPS	FROM	TO	FROM	TO
J6	PUMP 2	240V	7A	J7	AREA 3	J3	J55





